



www.chameleoncloud.org

CHAMELEON: TAKING SCIENCE FROM CLOUD TO EDGE

Kate Keahey

Mathematics and CS Division, Argonne National Laboratory

CASE, University of Chicago

keahey@anl.gov

December 2nd, 2021

CHPC National Conference 2021



SCIENTIFIC INSTRUMENTS

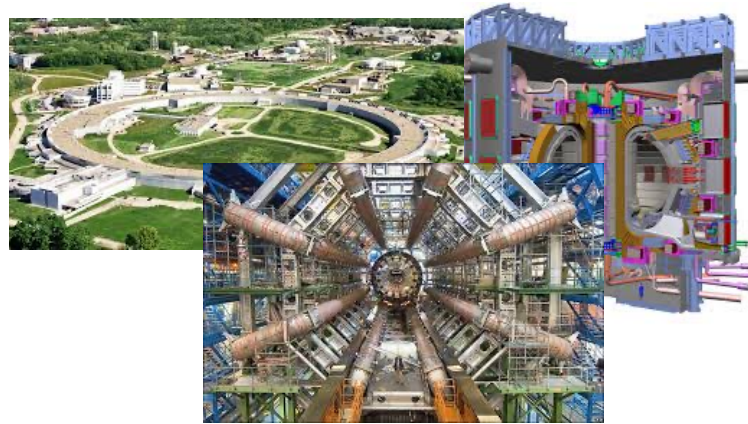

What scientific instruments do Computer Scientists need?

Innovative and diverse hardware, breadth of deployment, freedom to touch and measure every aspect of configuration and behavior.

Constantly evolving!

THE EMERGENCE OF IOT/EDGE

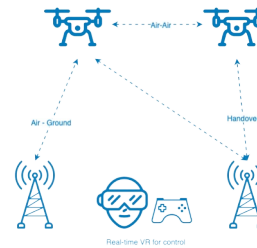
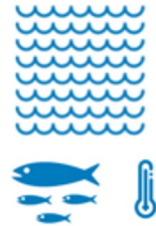

Challenges in connectivity, scale, security, dynamicity, resilience, data and information workflows, management – and many others!

CHAMELEON IN A NUTSHELL

- ▶ Chameleons like to change: a testbed that adapts itself to your experimental needs
 - ▶ **Deep reconfigurability** (bare metal) and isolation + KVM cloud (different cost/isolation trade-off)
 - ▶ Capabilities: power on/off, reboot, custom kernel, serial console access, etc.
- ▶ Balance: **large-scale** versus **diverse** hardware
 - ▶ Large-scale: ~large homogenous partition (~15,000 cores), ~6 PB of storage originally distributed over 2 sites (**UC, TACC**) connected with 100G network
 - ▶ Diverse: ARMs, Atoms, FPGAs, GPUs, Corsas switches, etc.
 - ▶ **CHI-in-a-Box** sites at Northwestern, in preparation: NCAR, IIT, and other places
- ▶ Cloud++: CHameleon Infrastructure (CHI) via mainstream cloud tech
 - ▶ Powered by **OpenStack** with bare metal reconfiguration (Ironic) + “special sauce” (50/50 split)
 - ▶ Blazar contribution recognized as official OpenStack component
- ▶ Reproducibility, repeatability, and sharing
 - ▶ **Jupyter integration** for imperative and non-transactional experiment packaging, **Chameleon daypass** for easy access, **Trovi** for sharing and finding experiments, integration with **Zenodo** for publishing



OPEN TESTBED – BY THE NUMBERS

450+

Papers
published

45

Countries

750+

Unique
projects

Over
6,000
Users

160+

Institutions

6+

Years Old

and 3 more
years to grow!

CHAMELEON HARDWARE

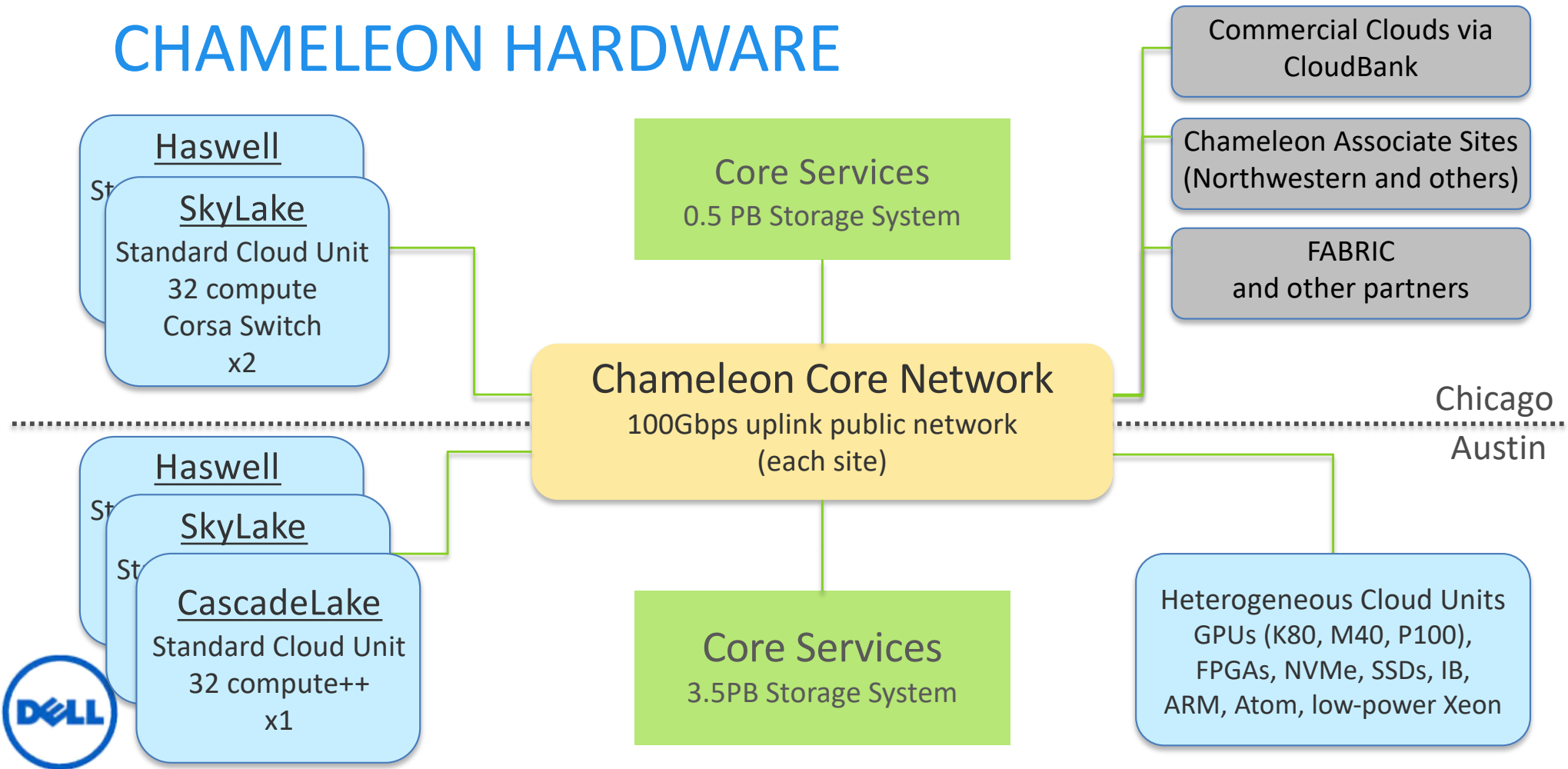

CHAMELEON HARDWARE (DETAILS)

- ▶ “Start with large-scale homogenous partition”
 - ▶ 12 Haswell racks, each with 42 Dell R630 compute servers with dual-socket Intel Haswell processors (24 cores) & 128GB RAM and 4 Dell FX2 storage servers with 16 2TB drives each; Force10 s6000 OpenFlow-enabled switches 10Gb to hosts, 40Gb uplinks to Chameleon core network
 - ▶ 3 SkyLake racks (32 nodes each); Corsa (DP2400 & DP2200), 100Gb uplinks to core network
 - ▶ CascadeLake rack (32 nodes), 100Gb uplinks to Chameleon core network
 - ▶ Allocations can be an entire rack, multiple racks, nodes within a single rack or across racks (e.g., storage servers across racks forming a Hadoop cluster)
- ▶ Shared infrastructure
 - ▶ 3.6 (TACC) + 0.5 (UC) PB global storage, 100Gb Internet connection between sites
- ▶ “Graft on heterogeneous features”
 - ▶ Infiniband with SR-IOV support, High-mem, NVMe, SSDs, P100 GPUs (total of 22 nodes), RTX GPUs (40 nodes), FPGAs (4 nodes)
 - ▶ ARM microservers (24) and Atom microservers (8), low-power Xeons (8)
- ▶ Coming in Phase 3: upgrading Haswells to CascadeLake and IceLake + AMD, new GPUs and FPGAs, more and newer IB fabric, variety of storage options for disaggregated hardware experiments, composable hardware (LiQid), networking (P4, integration with FABRIC), IoT devices -- and strategic reserve

CHI EXPERIMENTAL WORKFLOW

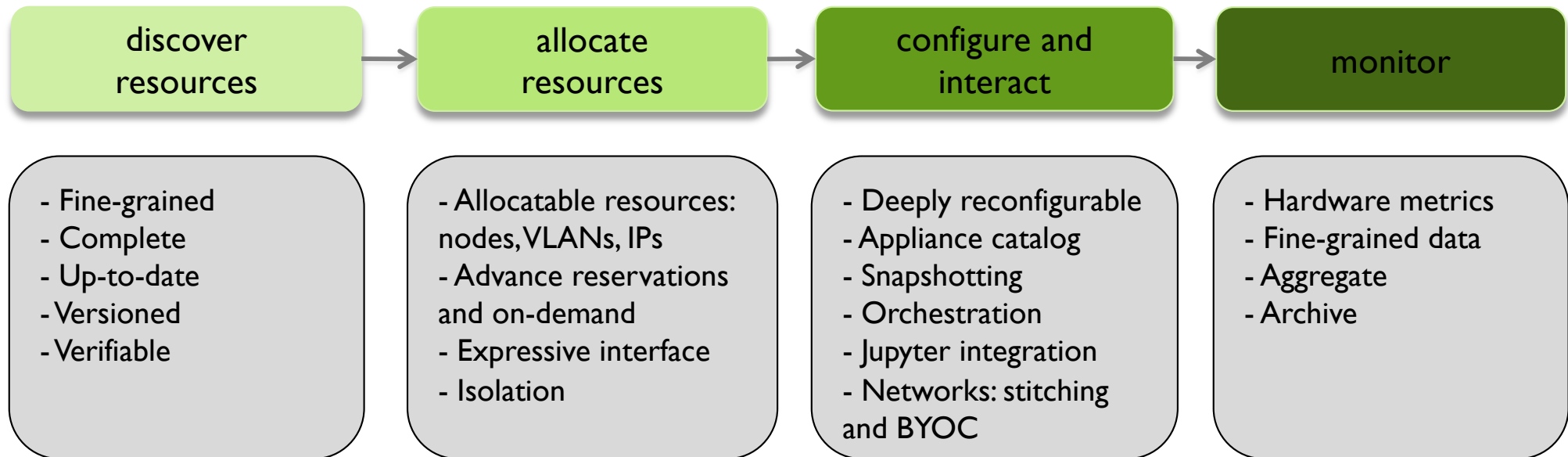

Authentication via federated identity, accessed via GUI, CLI and python/Jupyter

Paper: "Lessons Learned from the Chameleon Testbed", USENIX ATC 2020

VIRTUALIZATION OR CONTAINERIZATION?

- ▶ Yuyu Zhou, University of Pittsburgh
- ▶ Research: lightweight virtualization
- ▶ Testbed requirements:
 - ▶ Bare metal reconfiguration, isolation, and serial console access
 - ▶ The ability to “save your work”
 - ▶ Support for large scale experiments
 - ▶ Up-to-date hardware

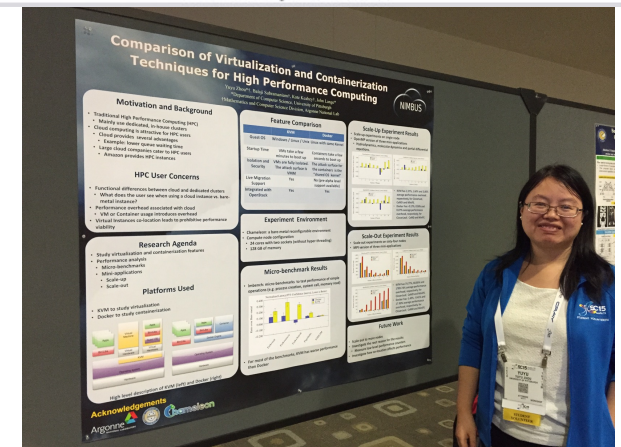
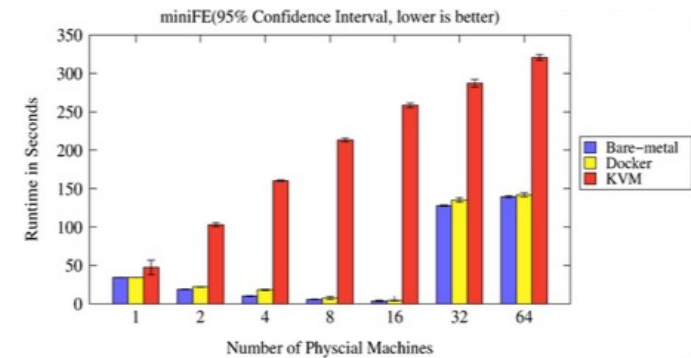

SC15 Poster: “Comparison of Virtualization and Containerization Techniques for HPC”

EXASCALE OPERATING SYSTEMS

- ▶ Swann Perarnau, ANL
- ▶ Research: exascale operating systems
- ▶ Testbed requirements:
 - ▶ Bare metal reconfiguration
 - ▶ Fast boot from custom kernel with different kernel parameters
 - ▶ Fast reconfiguration, many different images, kernels, parameters
 - ▶ Hardware: accurate information and control over changes, performance counters, many cores
 - ▶ Access to same infrastructure for multiple collaborators

HPPAC'16 paper: “Systemwide Power Management with Argo”

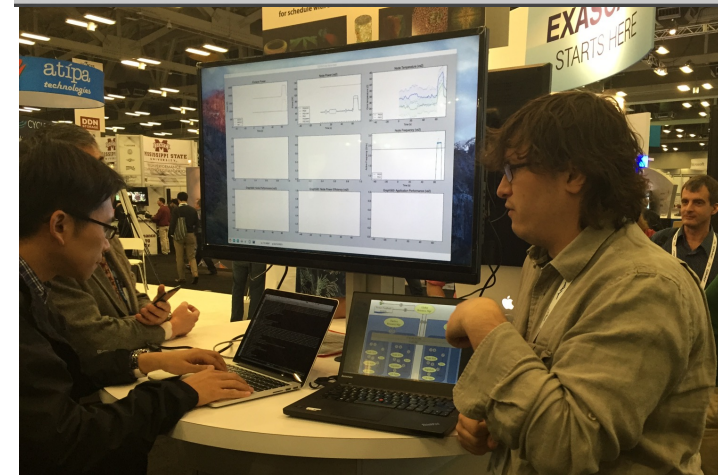
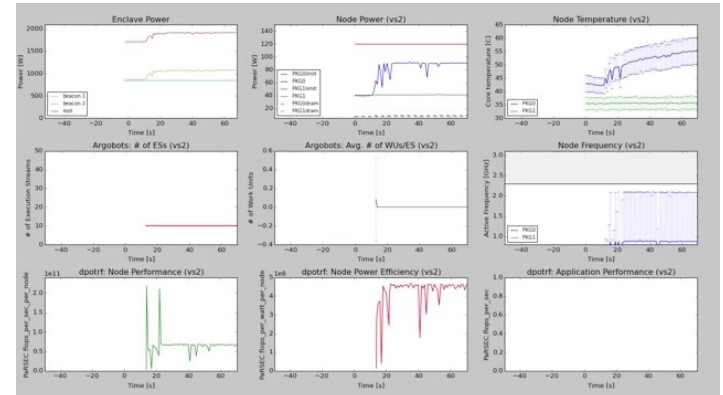

CLASSIFYING CYBERSECURITY ATTACKS

- ▶ Jessie Walker & team, University of Arkansas at Pine Bluff (UAPB)
- ▶ Research: modeling and visualizing multi-stage intrusion attacks (MAS)
- ▶ Testbed requirements:
 - ▶ Easy to use OpenStack installation
 - ▶ A selection of pre-configured images
 - ▶ Access to the same infrastructure for multiple collaborators



CREATING DYNAMIC SUPERFACILITIES

- ▶ NSF CICI SAFE, Paul Ruth, RENCI-UNC Chapel Hill
- ▶ Creating trusted facilities
 - ▶ Automating trusted facility creation
 - ▶ Virtual Software Defined Exchange (SDX)
 - ▶ Secure Authorization for Federated Environments (SAFE)
- ▶ Testbed requirements
 - ▶ Creation of dynamic VLANs and wide-area circuits
 - ▶ Support for network stitching
 - ▶ Managing complex deployments

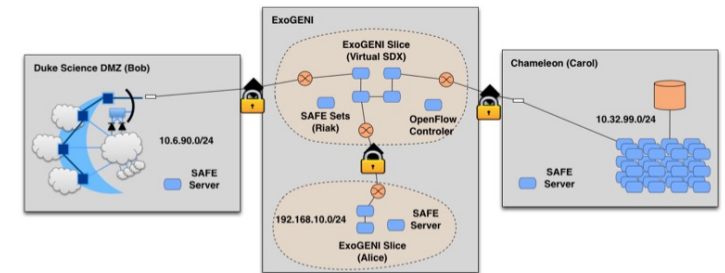

DATA SCIENCE RESEARCH

- ▶ ACM Student Research Competition semi-finalists:
 - ▶ Blue Keleher, University of Maryland
 - ▶ Emily Herron, Mercer University
- ▶ Searching and image extraction in research repositories
- ▶ Testbed requirements:
 - ▶ Access to distributed storage in various configurations
 - ▶ State of the art GPUs
 - ▶ Easy to use appliances and orchestration

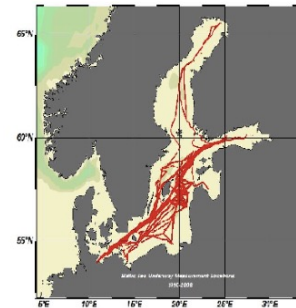

```
{  
  'header': {  
    'header_info':  
      'file': '237',  
      'file_unit': '1',  
      'exit': 'back/a',  
      'file_version':  
      'file_density':  
      'dpi': (96, 96)  
      'image_mode': 'rgb'  
      'dimensions': '930x'  
    'color': {  
      'mean_pixel_val'  
      'extrema': (0,  
      'mode_pixel_val'  
      'median_pixel_v'  
      'std_dev_pixel_  
    'system': {  
      'path': '/media'  
      'extension': '.'  
      'file': 'img.img'  
      'size': 1158111  
      'image_text': ['halt']  
      'name_tags': ['Minted']  
      'dvn_class_tags': []  
      'mean_colors_cluster'  
  }  
}
```

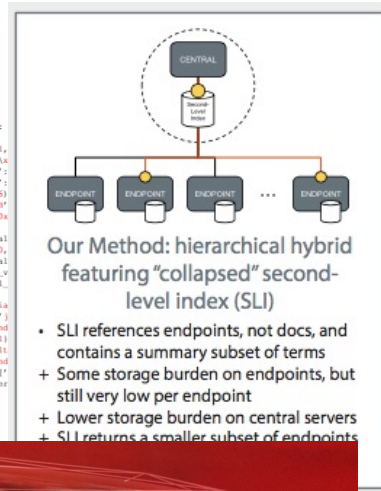

ADAPTIVE BITRATE VIDEO STREAMING

- ▶ Divyashri Bhat, UMass Amherst
- ▶ Research: application header based traffic engineering using P4
- ▶ Testbed requirements:
 - ▶ Distributed testbed facility
 - ▶ BYOC – the ability to write an SDN controller specific to the experiment
 - ▶ Multiple connections between distributed sites
- ▶ <https://vimeo.com/297210055>

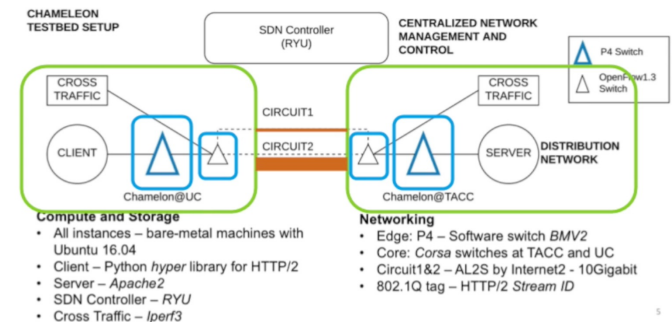

LCN'18: “Application-based QoS support with P4 and OpenFlow”

POWER CAPPING

- ▶ Harper Zhang, University of Chicago
- ▶ Research: hierarchical, distributed, dynamic power management system for dependent applications
- ▶ Testbed requirements:
 - ▶ Support for large-scale experiments
 - ▶ Complex appliances and orchestration (NFS appliance)
 - ▶ RAPL/power management interface
- ▶ Finalist for SC19 Best Paper and Best Student Paper
- ▶ Talk information at bit.ly/SC19PoDD

SC'19: "PoDD: Power-Capping Dependent Distributed Applications"



FROM CLOUD TO EDGE WITH CHAMELEON

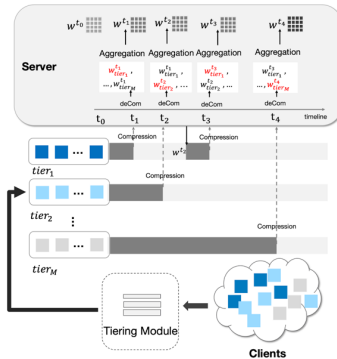

federated learning

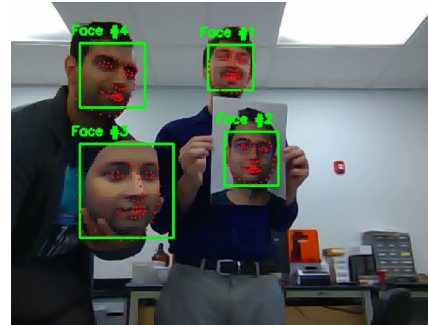

biometrics

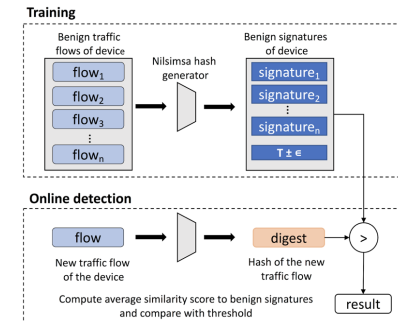

network traffic fingerprinting for IoT devices

- ▶ Increasingly more Chameleon project applications working on IoT/edge
- ▶ Simulation/emulation don't always provide the answer: What are the impacts of this approach on power management on edge device? How will the performance transfer to edge? Can we measure the impact of distribution/networking for edge/cloud applications?
- ▶ Goal: “realistic edge to cloud experiments from one Jupyter notebook”

WHAT DOES AN EDGE TESTBED LOOK LIKE?



A lot like a cloud!
All the features we know
and love but for edge!

Not at all like a cloud!
Location, location, location!
Not server-class!
IoT: cameras, actuators, SDRs!
And many other challenges!



- ▶ CHI@Edge: all the features you know and love plus
 - ▶ Reconfiguration via container deployment
 - ▶ Support for peripherals based on an extensible plug-in model
 - ▶ **Mixed ownership** model via an SDK with devices, virtual site, and **restricted sharing**
 - ▶ And others... Chameleon@Edge Community Workshop in September 2021
<https://chameleoncloud.org/chiedge-community-workshop/>

WHAT DOES AN EDGE TESTBED LOOK LIKE?

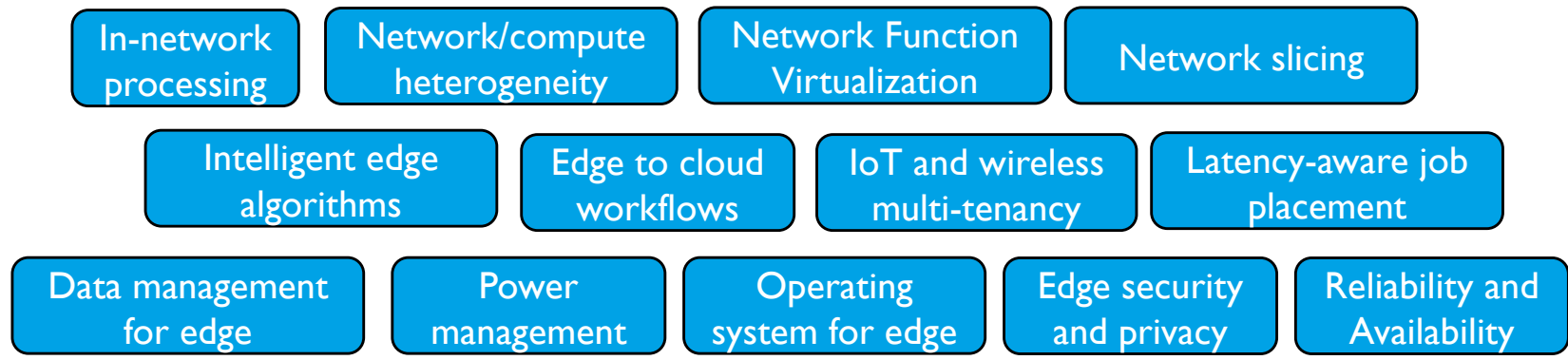

CHI@Edge



chameleon-owned devices



user-owned devices

BUILDING CHI@EDGE



CHI@EDGE EXPERIMENTAL WORKFLOW (PREVIEW)

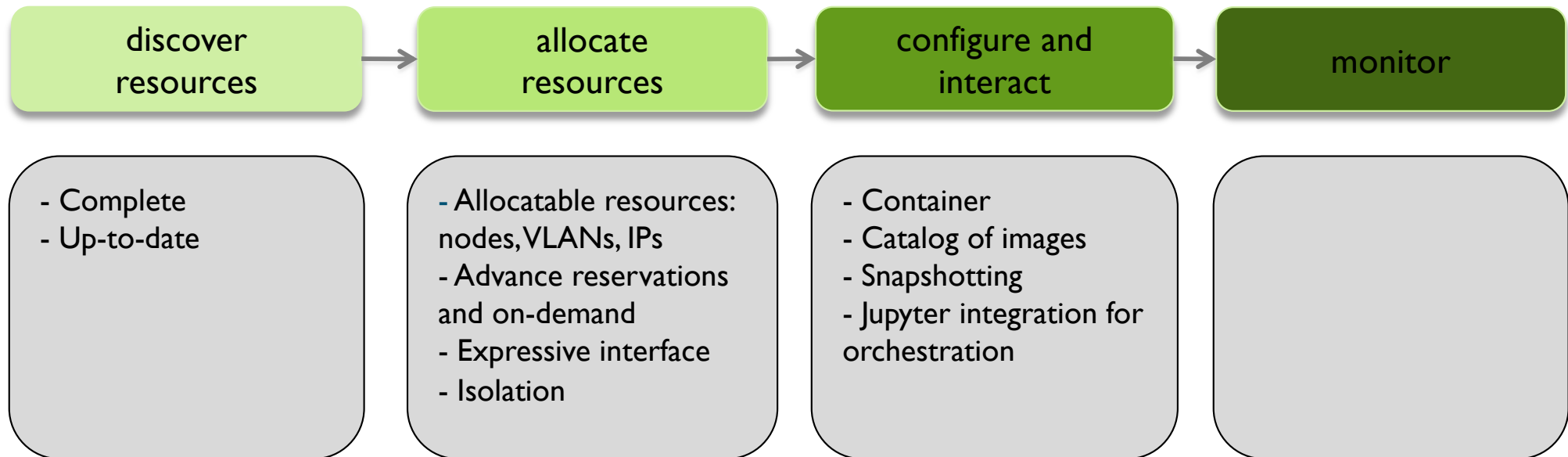

Authentication via federated identity, accessed via GUI, CLI and python/Jupyter

SHARING DEVICES THROUGH CHI@EDGE

- ▶ CHI@Edge SDK: fully automate the process of enrolling a device into CHI@Edge
- ▶ Support for **restricted leases**
 - ▶ You operate your device for your community and leverage our expertise on sharing
 - ▶ Your users get seamless access to the devices you operate for them + Chameleon + partnerships
- ▶ Access reasonable hardware properties e.g., GPUs
- ▶ Peripheral devices
 - ▶ Standard camera modules, GPIO, SDR
 - ▶ Extensible framework for integrating new devices
- ▶ CHI@Edge in a Box – in development

AUTONOMOUS CARS WITH CHI@EDGE



Rick Anderson
Virtual Worlds, Director
Rutgers University

- ▶ Goal:
 - ▶ Teach machine learning and systems concepts using remote autonomous cars
- ▶ Challenges:
 - ▶ Control the cars remotely: manual workflows require lots of teacher effort
 - ▶ Iterate on code while learning and exploring
 - ▶ Collect, store, and process large datasets
- ▶ CHI@Edge:
 - ▶ Car reservations
 - ▶ Access through JupyterHub
 - ▶ Provides consistent network connection
 - ▶ Deploy code and collect results with repeatable workflows



```
#!/usr/bin/env python
chi.use_site("CHI@Edge")
chi.set("project_name", "CHI-?????")

#Reserve a container lease
lease.add_device_reservation(reservations=[], count = 2, device_model = "4")
container_lease = lease.create_lease("lease", reservations)
lease.wait_for_active(container_lease["id"])
print("Lease: {container_lease['name']} is available.")

#provision containers and append them to a hashmap
PORT = "7777"
DIR = "/var/www/html"
letter_list = [chr(ord('a')+i) for i in range(container_lease["reservations"][0]["max"])]
device_list = [container.create_container(name = f"container-{letter}",
                                         image = "id",
                                         image_driver = "glance",
                                         workdir = DIR,
                                         exposed_ports = [PORT],
                                         command = ["python3", "-m", "http.server", PORT],
                                         reservation_id = container_lease["reservations"][0]["id"])
               for letter in letter_list]

edge_device = dict(zip(letter_list, device_list))

container.execute("container-a", "python3 -c 'import this'")
```

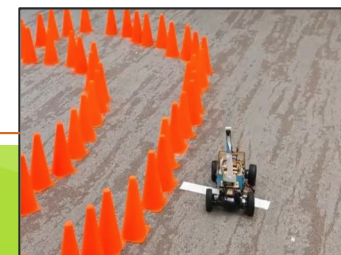
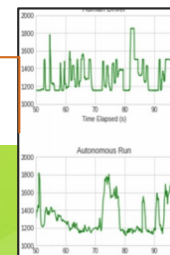
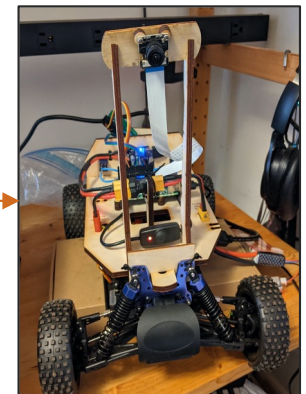

ARA: WIRELESS LIVING LAB FOR SMART & CONNECTED RURAL COMMUNITIES

▶ ARA objectives

- ▶ Enable research to achieve a factor of 10+ reduction in broadband cost and make rural broadband as affordable as urban broadband!
- ▶ Support broadband use cases for rural communities

▶ ARA wireless living lab

- ▶ Deploy advanced wireless platforms in Central Iowa (>600 square miles); capture systems and application and community contexts of rural broadband
- ▶ Mainstream open-source platforms for living lab management and experimentation: OpenStack, CHI-in-a-Box & CHI@Edge, ONF (SD-RAN, SD-CORE, ONOS), srsRAN, OpenAirInterface etc
- ▶ CHI@Edge: collaborating on spectrum reservations for management of wireless networks and CHI@Edge in a Box



Hongwei Zhang, ARA PI
Iowa State University

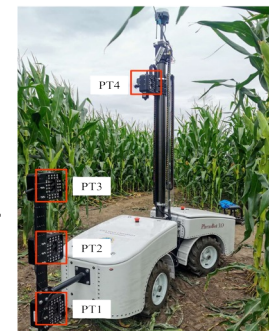

Location and Interior view of
ISU Beef Nutrition Research Farm

EDGE FOR MARINE BIOLOGY

- ▶ Goal: map existing fish populations and thereby understand better how pollution impacts their habitat and the general Biscayne Bay ecosystem
- ▶ Challenges: What is the best cloud/edge strategy for collecting and analyzing data from the autonomous vehicle (AV)? How does the resolution of video data and quality of network connection influence them?
- ▶ CHI@Edge: using CHI@Edge for developing edge to cloud data processing workflows via Jupyter notebooks

Kevin Boswell, Leonardo Bobadilla,
and Jonathan Tsen
Florida International University

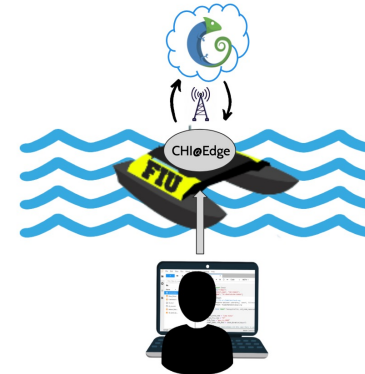
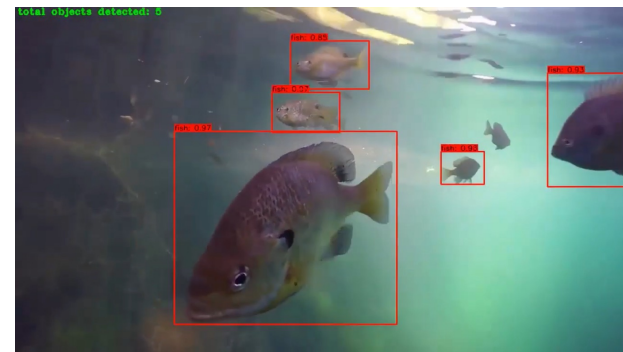
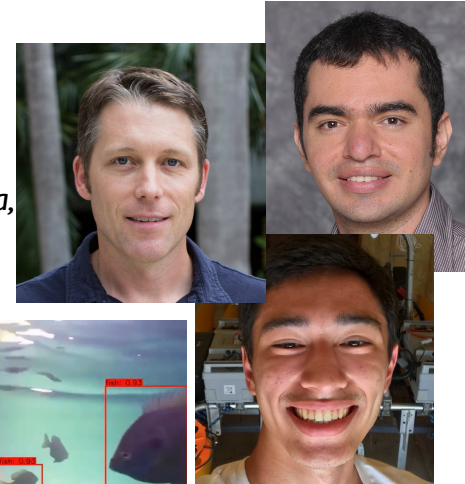

FLYNET: AN 'ON-THE-FLY' PROGRAMMABLE END-TO-END NETWORK-CENTRIC PLATFORM

- ▶ Architecture and tools that support edge computing devices in scientific workflows
- ▶ Critical for low latency and ultra-low latency applications: e.g., drone video analytics and route planning for drones
- ▶ Challenges: integration of compute and networking infrastructure, in-network processing, end-to-end monitoring, workflow management (Pegasus)
- ▶ CHI@Edge
 - ▶ Use for edge computing experiments
 - ▶ Provide experiments that can be reproduced by other researchers
 - ▶ FlyNet to provide tools to allow researcher to include CHI@Edge in their workflows

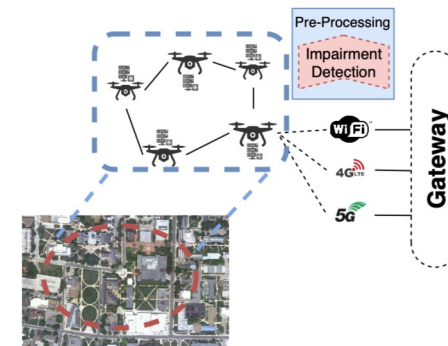

Mike Zink FlyNet PI
U of Mass, Amherst

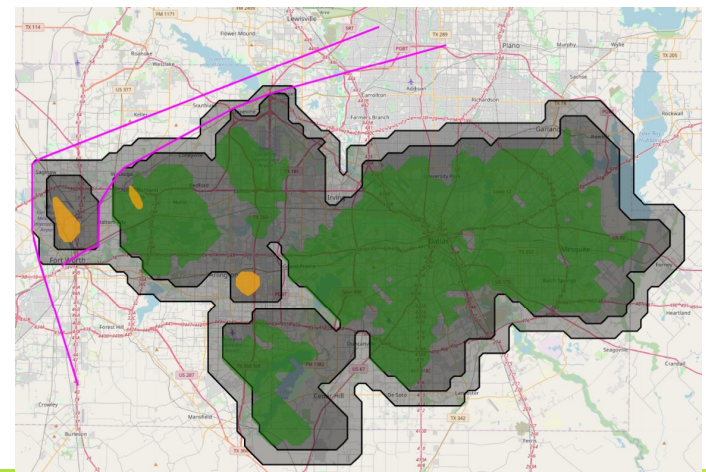

PRACTICAL REPRODUCIBILITY

- ▶ Can experiments be as sharable as papers are today?
- ▶ Could it be as easy to provide conditions for reviewers to repeat experiments or data analysis in a paper as it is to organize a PC meeting?
- ▶ Can I simply integrate somebody's model into my research instead of reinventing the wheel?
- ▶ Can I have so much fun playing with somebody's experiment that discover a new result?
- ▶ Can I develop exercises for my class based on most recent research results?

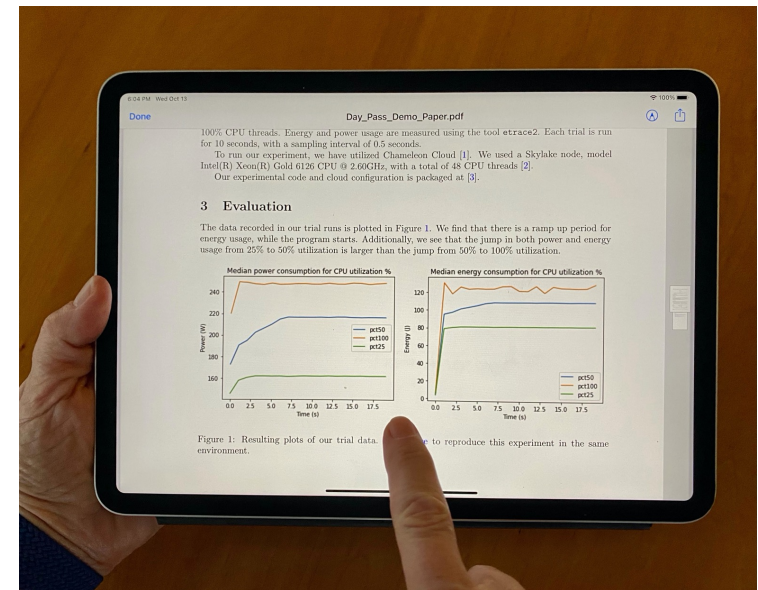

The existence of powerful open testbeds is a fundamental requirement for practical reproducibility

TESTBED AS SHARING PLATFORM

- ▶ **Instruments held in common** are a reproducibility imperative
 - ▶ Hardware and hardware versions: >105 versions over 5 years
 - ▶ Expressive allocation
- ▶ **Sharing via **cloud pattern****
 - ▶ Disk images, orchestration templates, and other artifacts
 - ▶ Chameleon >130,000 images, >35,000 orchestration templates and counting
- ▶ Testbed as “player” for environments



Paper: “The Silver Lining”, IEEE Internet Computing 2020

WHAT IS MISSING?

- ▶ Packaging: complete, imperative, **non-transactional**, integrated (literate programming)

- ▶ Get access for reproducibility

- ▶ Discover/find experiments through various channels



- ▶ Package experiment in a way that is cost-effective but also user-friendly

- ▶ Give access for reproducibility

- ▶ Share work in progress; publish and advertise completed work



TESTBED ACCESS WITH CHAMELEON DAYPASS

- ▶ Authors create a subproject with multiple short-term leases that are long enough to reproduce the experiment
- ▶ Readers click through data of a published experiment, request a daypass, and reproduce either the experiment or data analysis

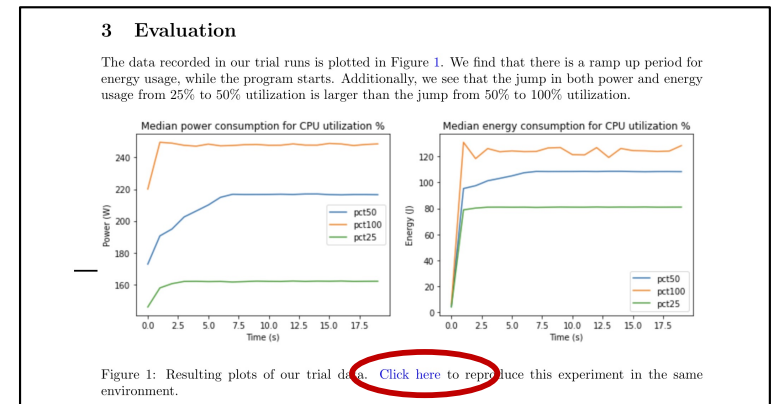

Chameleon About Learn Experiment Blog Log in

Artifacts / Getting Started with Chameleon: Power management experiment

Getting Started with Chameleon: Power management experiment

This notebook is a short example of how to use Chameleon notebooks to run a simple experiment, and analyze the data, using the python-chi interface.

Estimated duration: 1 hour
Support contact: help@chameleoncloud.org

2 Sept. 29, 2021, 12:44 p.m. example experiment

Authors
Jason Anderson (University of Chicago)
Mark Powers (University of Chicago)

Request day pass

If you do not have an active Chameleon allocation, or would prefer to not use your allocation, you can request a temporary one from the PI of the project this artifact belongs to.

Versions

Version 2	Sept. 29, 2021, 12:43 p.m.
Version 1	Sept. 29, 2021, 12:37 p.m.

SHARING AND FINDING EXPERIMENTS

Familiar research sharing ecosystem

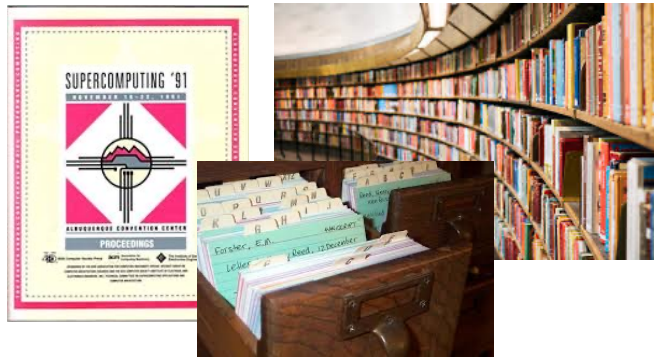

Digital research sharing ecosystem



- ▶ Digital publishing with Zenodo: make your experiments citable via Digital Object Identifiers (DOIs)
- ▶ Trovi: sharing work in progress
 - ▶ BINs to collect all the artifacts, fine-grained sharing, versioning
 - ▶ Portal to browse, filter, and find interesting experiments
 - ▶ Integrated with Jupyter/Chameleon, Swift, Zenodo, and github (in progress)



PARTING THOUGHTS

- ▶ Constantly in motion: scientific instruments are laying down the pavement as science walks on it
- ▶ **Testbed evolution:** from cloud to edge
 - ▶ Before: expensive **provider-owned** hardware as the main draw
 - ▶ Now: **user-owned** inexpensive hardware using testbed **sharing and connecting** mechanisms
 - ▶ Testbeds == effective **sharing and connecting** mechanism + residual resources
- ▶ **Sharing your research digitally is more important than ever!**
 - ▶ Make it easy with Chameleon: public platform, environments as images, packaging, access, and sharing mechanisms at the ready
 - ▶ Biggest benefit in emergent area == real incentives

Think Big!

(with the help of a small reptile)



www.chameleoncloud.org