



www.chameleoncloud.org

THE MANY COLORS OF CHAMELEON

Kate Keahey

Mathematics and CS Division, Argonne National Laboratory

CASE, University of Chicago

keahey@anl.gov

September 10, 2019

PPAM 2019



CHAMELEON IN A NUTSHELL

- ▶ We like to change: testbed that adapts itself to your experimental needs
 - ▶ Deep reconfigurability (bare metal) and isolation (CHI) – but also ease of use (KVM)
 - ▶ CHI: power on/off, reboot, custom kernel, serial console access, etc.
- ▶ We want to be all things to all people: balancing large-scale and diverse
 - ▶ Large-scale: ~large homogenous partition (~15,000 cores), 5 PB of storage distributed over 2 sites (now +1!) connected with 100G network...
 - ▶ ...and diverse: ARMs, Atoms, FPGAs, GPUs, Corsa switches, etc.
- ▶ Cloud++: leveraging mainstream cloud technologies
 - ▶ Powered by OpenStack with bare metal reconfiguration (Ironic) + “special sauce”
 - ▶ Chameleon team contribution recognized as official OpenStack component
- ▶ We live to serve: open, production testbed for Computer Science Research
 - ▶ Started in 10/2014, testbed available since 07/2015, renewed in 10/2017
 - ▶ Currently 3,500+ users, 500+ projects, 100+ institutions

CHAMELEON HARDWARE

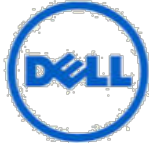
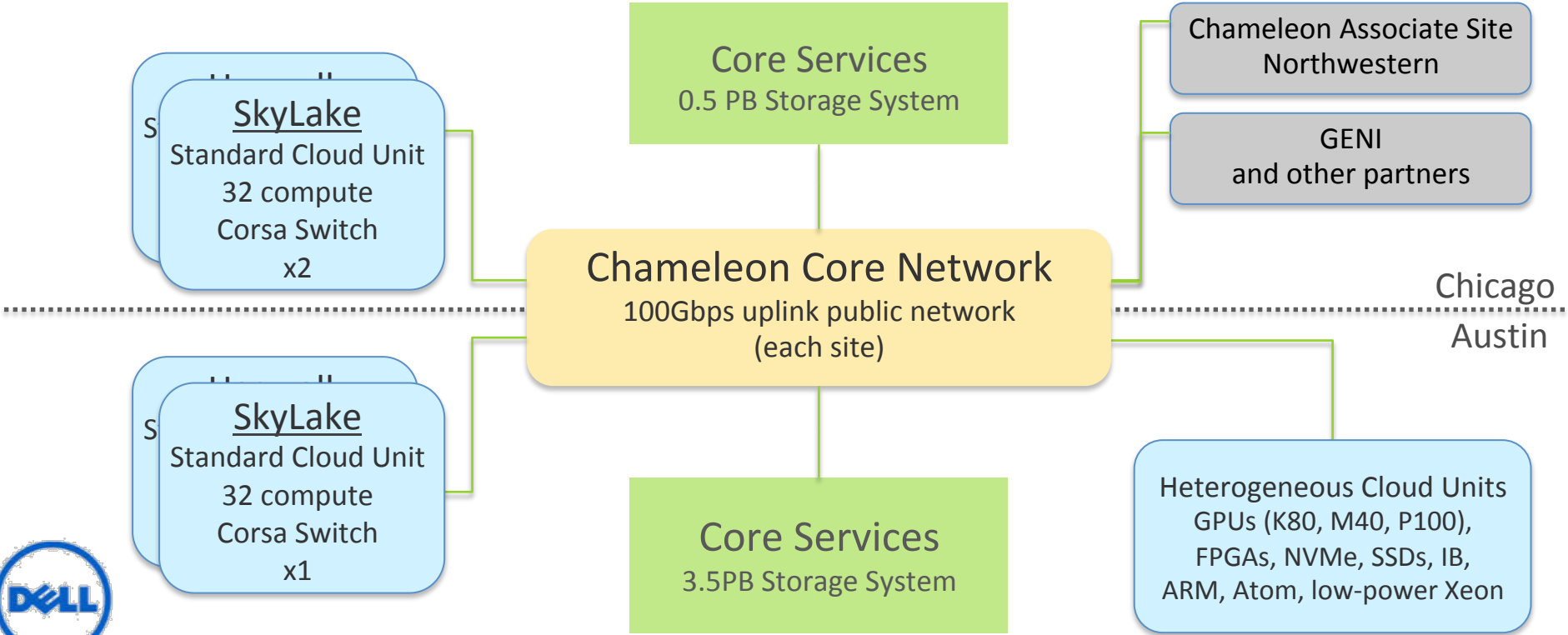

CHAMELEON HARDWARE (DETAILS)

- ▶ “Start with large-scale homogenous partition”
 - ▶ 12 Haswell Standard Cloud Units (48 node racks), each with 42 Dell R630 compute servers with dual-socket Intel Haswell processors (24 cores) and 128GB RAM and 4 Dell FX2 storage servers with 16 2TB drives each; Force10 s6000 OpenFlow-enabled switches 10Gb to hosts, 40Gb uplinks to Chameleon core network
 - ▶ 3 SkyLake Standard Cloud Units (32 node racks); Corsa (DP2400 & DP2200) switches, 100Gb uplinks to Chameleon core network
 - ▶ Allocations can be an entire rack, multiple racks, nodes within a single rack or across racks (e.g., storage servers across racks forming a Hadoop cluster)
- ▶ Shared infrastructure
 - ▶ 3.6 + 0.5 PB global storage, 100Gb Internet connection between sites
- ▶ “Graft on heterogeneous features”
 - ▶ Infiniband with SR-IOV support, High-mem, NVMe, SSDs, GPUs (22 nodes), FPGAs (4 nodes)
 - ▶ ARM microservers (24) and Atom microservers (8), low-power Xeons (8)
- ▶ Coming soon: more nodes (CascadeLake), and more accelerators

EXPERIMENTAL WORKFLOW

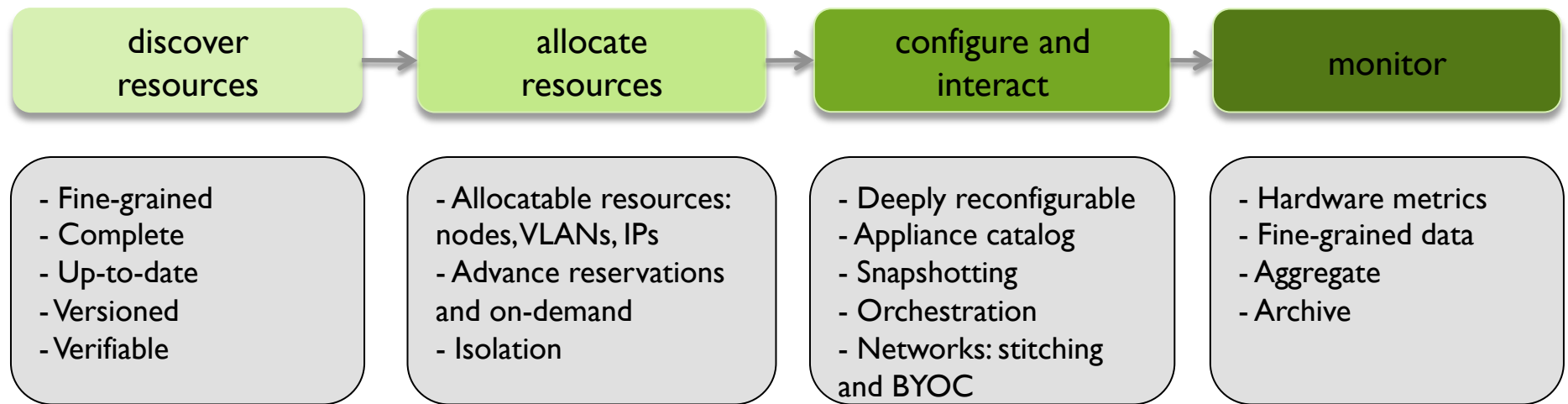

CHI = 65%*OpenStack + 10%*G5K + 25%*”special sauce”

RECENT DEVELOPMENTS

- ▶ Allocatable resources
 - ▶ Multiple resource management (nodes, VLANs, IP addresses), adding/removing nodes to/from a lease, lifecycle notifications, advance reservation orchestration
- ▶ Networking
 - ▶ Multi-tenant networking,
 - ▶ Stitching dynamic VLANs from Chameleon to external partners (ExoGENI, ScienceDMZs),
 - ▶ VLANs + AL2S connection between UC and TACC for 100G experiments
 - ▶ BYOC– Bring Your Own Controller: isolated user controlled virtual OpenFlow switches
- ▶ Miscellaneous features
 - ▶ Power metrics, usability features, new appliances, etc.

VIRTUALIZATION OR CONTAINERIZATION?

- ▶ Yuyu Zhou, University of Pittsburgh
- ▶ Research: lightweight virtualization
- ▶ Testbed requirements:
 - ▶ Bare metal reconfiguration, isolation, and serial console access
 - ▶ The ability to “save your work”
 - ▶ Support for large scale experiments
 - ▶ Up-to-date hardware

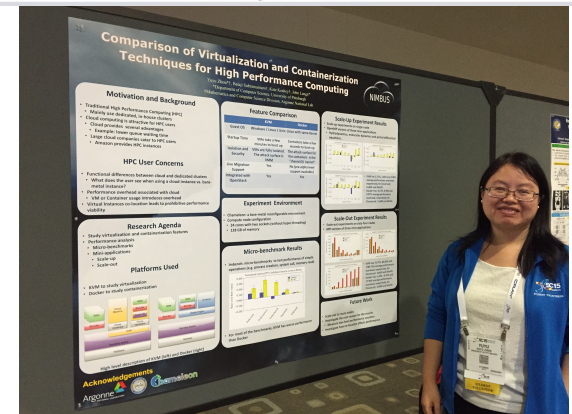
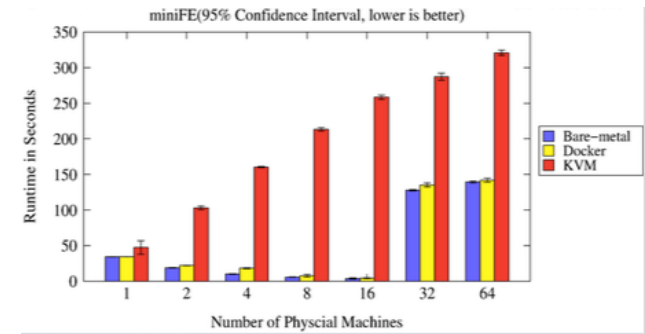

SCI5 Poster: “Comparison of Virtualization and Containerization Techniques for HPC”

EXASCALE OPERATING SYSTEMS

- ▶ Swann Perarnau, ANL
- ▶ Research: exascale operating systems
- ▶ Testbed requirements:
 - ▶ Bare metal reconfiguration
 - ▶ Boot from custom kernel with different kernel parameters
 - ▶ Fast reconfiguration, many different images, kernels, parameters
 - ▶ Hardware: accurate information and control over changes, performance counters, many cores
 - ▶ Access to same infrastructure for multiple collaborators

HPPAC'16 paper: "Systemwide Power Management with Argo"

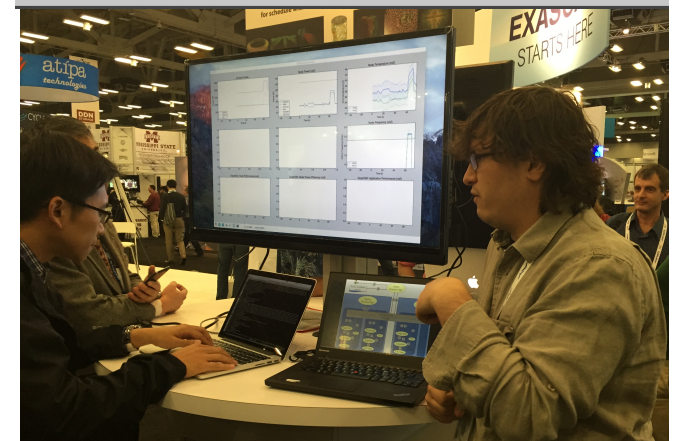
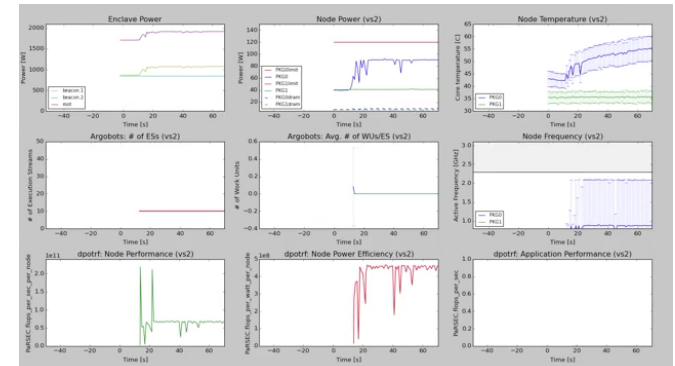

CLASSIFYING CYBERSECURITY ATTACKS

- ▶ Jessie Walker & team, University of Arkansas at Pine Bluff (UAPB)
- ▶ Research: modeling and visualizing multi-stage intrusion attacks (MAS)
- ▶ Testbed requirements:
 - ▶ Easy to use OpenStack installation
 - ▶ A selection of pre-configured images
 - ▶ Access to the same infrastructure for multiple collaborators



CREATING DYNAMIC SUPERFACILITIES

- ▶ NSF CICI SAFE, Paul Ruth, RENCI-UNC Chapel Hill
- ▶ Creating trusted facilities
 - ▶ Automating trusted facility creation
 - ▶ Virtual Software Defined Exchange (SDX)
 - ▶ Secure Authorization for Federated Environments (SAFE)
- ▶ Testbed requirements
 - ▶ Creation of dynamic VLANs and wide-area circuits
 - ▶ Support for network stitching
 - ▶ Managing complex deployments

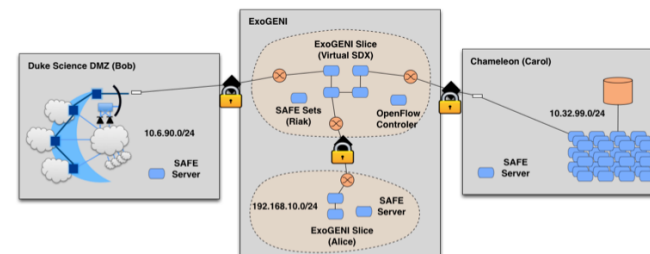

DATA SCIENCE RESEARCH

- ▶ ACM Student Research Competition semi-finalists:
 - ▶ Blue Keleher, University of Maryland
 - ▶ Emily Herron, Mercer University
- ▶ Searching and image extraction in research repositories
- ▶ Testbed requirements:
 - ▶ Access to distributed storage in various configurations
 - ▶ State of the art GPUs
 - ▶ Easy to use appliances and orchestration

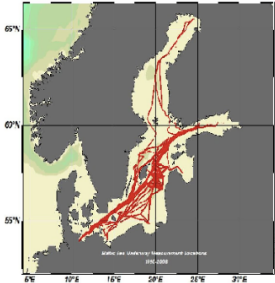

```
{ "header_info": { "jif": 257, "jif_unit": 1, "mexif": "MEXIF", "jif_version": "jif_density", "dpi": 196, "img_mode": "RGB", "dimensions": "930x", "color": { "mean_pixel_val": 0.0, "maxima": [0], "mode_pixel_val": 0.0, "median_pixel_v": 0.0, "std_dev_pixel_": 0.0, "system": { "path": "/media", "accession": "1", "file": "00_000", "size": 158111, "image_size": [1000, 1000], "name_tag": "10000", "DVM_class_tag": "1", "mean_color_cluster": 0.0 } } }
```

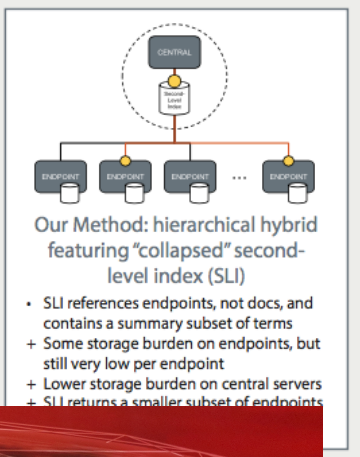

ADAPTIVE BITRATE VIDEO STREAMING

- ▶ Divyashri Bhat, UMass Amherst
- ▶ Research: application header based traffic engineering using P4
- ▶ Testbed requirements:
 - ▶ Distributed testbed facility
 - ▶ BYOC – the ability to write an SDN controller specific to the experiment
 - ▶ Multiple connections between distributed sites
- ▶ <https://vimeo.com/297210055>

LCN'18: “Application-based QoS support with P4 and OpenFlow”

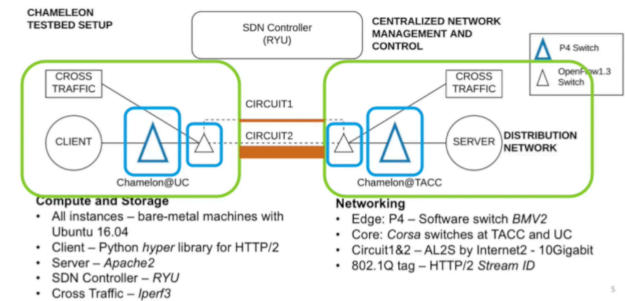

AN OPEN PLATFORM

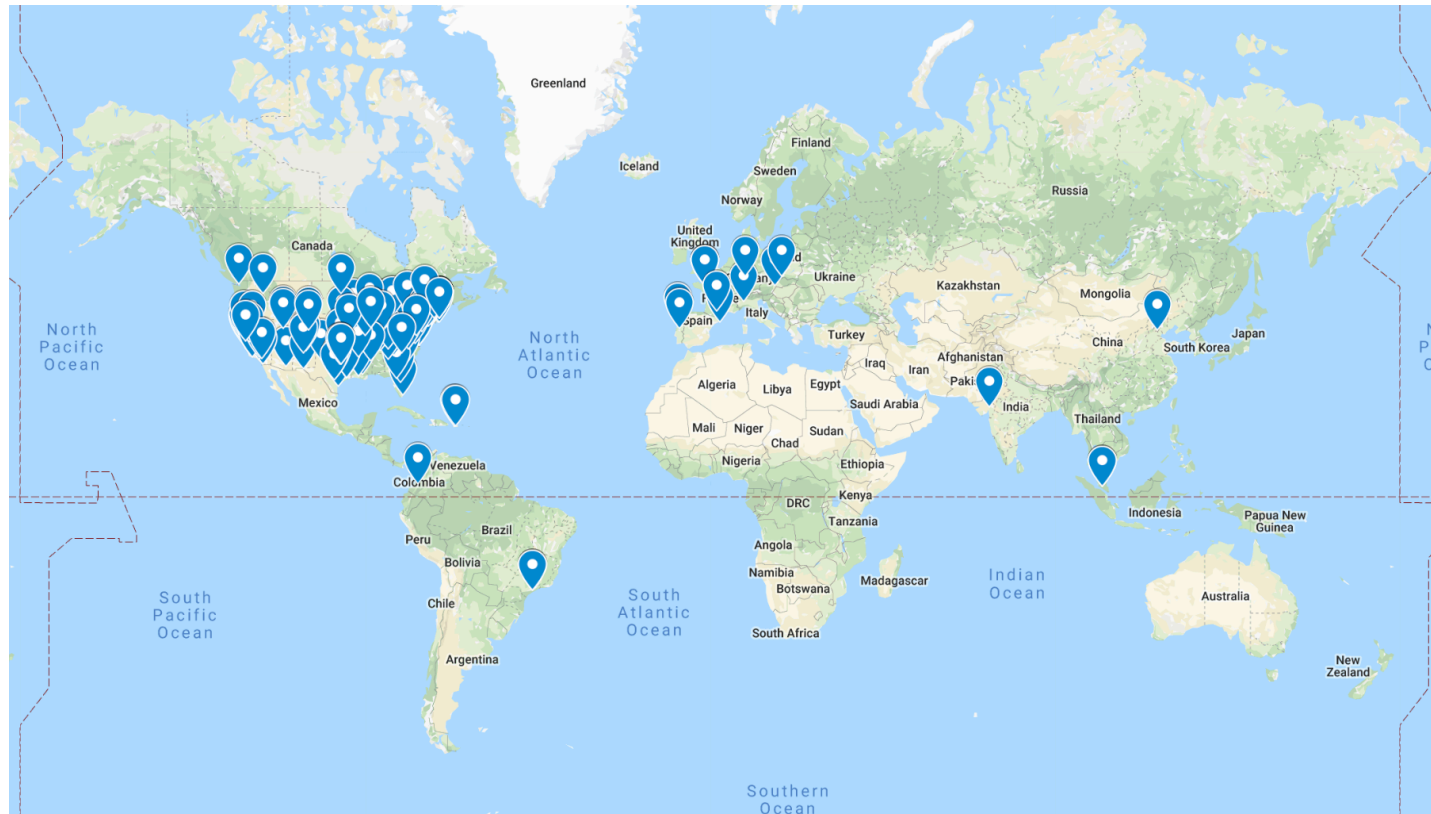

BEYOND THE PLATFORM: BUILDING AN ECOSYSTEM

- ▶ Helping hardware providers interact
 - ▶ Bring Your Own Hardware (BYOH)
 - ▶ CHI-in-a-Box: deploy your own Chameleon site
- ▶ Helping our user interact – with us but primarily with each other
 - ▶ Creating compatible digital artifacts: tools, appliances, orchestration templates, notebooks, etc.
 - ▶ Publishing, sharing, and discovering artifacts: appliance catalog, blog as a publishing platform, etc.
 - ▶ Testbed as a “player” for common artifacts



CHI-IN-A-BOX

- ▶ CHI-in-a-box: packaging a commodity-based testbed
 - ▶ First released in summer 2018, continuously improving
- ▶ CHI-in-a-box scenarios
 - ▶ Independent testbed: package assumes independent account/project management, portal, and support
 - ▶ Chameleon extension: join the Chameleon testbed (currently serving only selected users), and includes both user and operations support
 - ▶ Part-time extension: define and implement contribution models
 - ▶ Part-time Chameleon extension: like Chameleon extension but with the option to take the testbed offline for certain time periods (support is limited)
- ▶ Adoption
 - ▶ New Chameleon Associate Site at Northwestern since fall 2018 – new networking!
 - ▶ Two organizations working on independent testbed configuration



REPRODUCIBILITY DILEMMA

Should I invest in making my experiments repeatable?



Should I invest in more new research instead?

- ▶ Reproducibility as side-effect: lowering the cost of repeatable research
 - ▶ Example: Linux “history” command
 - ▶ From a meandering scientific process to a recipe
- ▶ Reproducibility by default: documenting the process via interactive papers

REPEATABILITY MECHANISMS IN CHAMELEON

- ▶ Testbed versioning (collaboration with Grid'5000)
 - ▶ Based on representations and tools developed by G5K
 - ▶ >50 versions since public availability – and counting
 - ▶ Still working on: better firmware version management
- ▶ Appliance management
 - ▶ Configuration, versioning, publication
 - ▶ Appliance meta-data via the appliance catalog
 - ▶ Orchestration via OpenStack Heat
- ▶ Monitoring and logging
- ▶ However... the user still has to keep track of this information

KEEPING TRACK OF EXPERIMENTS

- ▶ Everything in a testbed is a recorded event... or could be
- ▶ The resources you used
- ▶ The appliance/image you deployed
- ▶ The monitoring information your experiment generated
- ▶ Plus any information you choose to share with us: e.g., “start power_exp_23” and “stop power_exp_23”

-
- ▶ Experiment précis: information about your experiment made available in a “consumable” form

REPEATABILITY: EXPERIMENT PRÉCIS

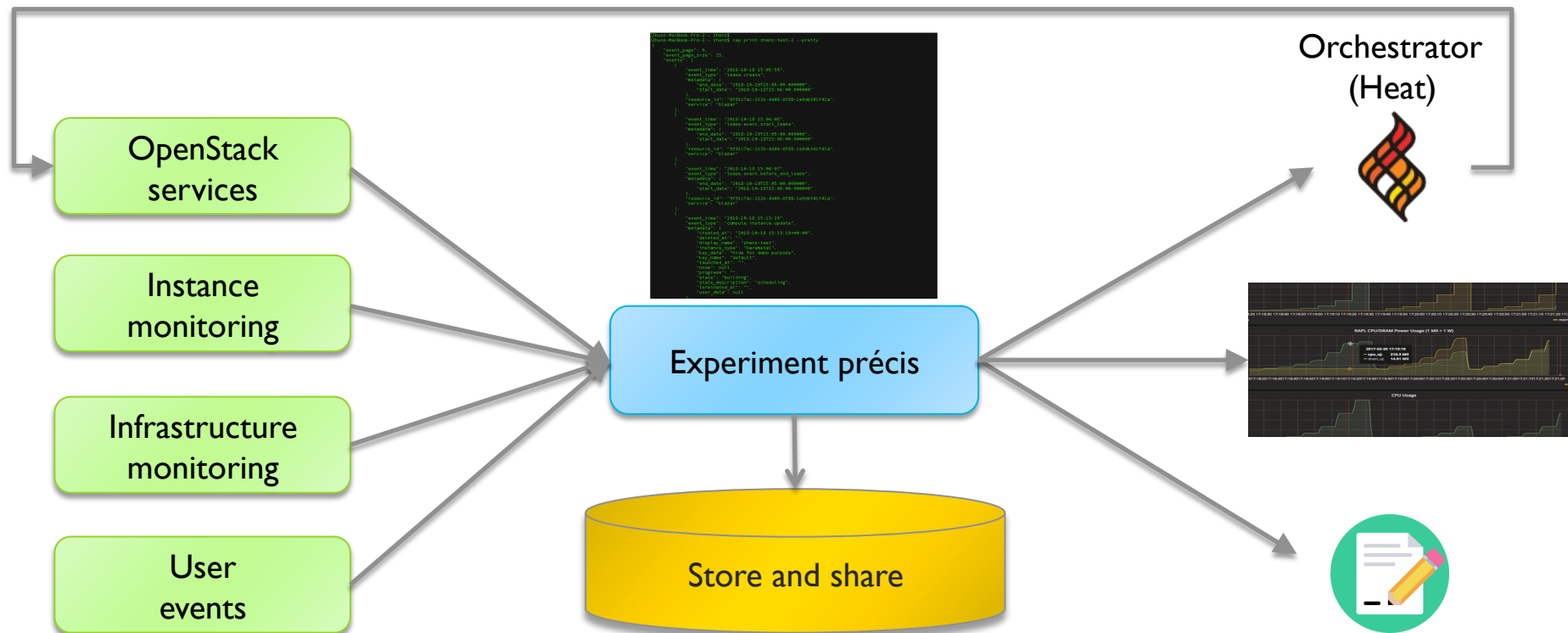

INTERACTIVE PAPERS

- ▶ What does it mean to document a process?
- ▶ Some requirements
 - ▶ Easy to work with: human readable/modifiable format
 - ▶ One process to rule them all: integrates well with ALL aspects of experiment management
 - ▶ Bit by bit – allows for modification and introspection as well – reflects the meandering scientific process
 - ▶ Support story telling: allows you to explain your experiment design and methodology choices
 - ▶ Has a direct relationship to the actual paper that gets written
 - ▶ Can be version controlled
 - ▶ Sustainable, a popular open source choice
- ▶ Implementation options
 - ▶ Orchestrators -- OpenStack Heat and Flame – a declarative approach
 - ▶ Notebooks -- Jupyter, NextJournal, and others – an imperative and integrative approach

CHAMELEON JUPYTER INTEGRATION

- ▶ Combining the ease of notebooks and the power of a shared platform
 - ▶ Storytelling with Jupyter: ideas/text, process/code, results – but limited containers
 - ▶ Chameleon: sophisticated experimental containers in need of “storytelling”
- ▶ JupyterLab server for our users
 - ▶ Go to jupyter.chameleoncloud.org and log in with your Chameleon credentials
- ▶ Chameleon/Jupyter integration
 - ▶ Interfaces: python and bash for all the main testbed functions
 - ▶ Working with named containers
- ▶ Templates of existing experiments

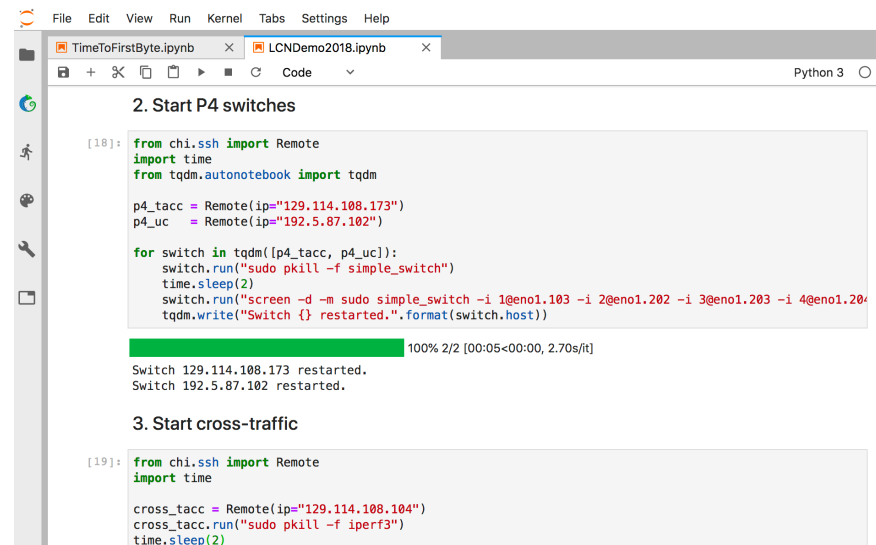

```
File Edit View Run Kernel Tabs Settings Help
TimeToFirstByte.ipynb x LCNDemo2018.ipynb x Python 3
+ 🔍 📄 ▶ ⏪ ⏩ Code
2. Start P4 switches
[18]: from chi.ssh import Remote
import time
from tqdm.autonotebook import tqdm

p4_tacc = Remote(ip="129.114.108.173")
p4_uc = Remote(ip="192.5.87.102")

for switch in tqdm([p4_tacc, p4_uc]):
    switch.run("sudo pkill -f simple_switch")
    time.sleep(2)
    switch.run("screen -d -m sudo simple_switch -i 1@eno1.103 -i 2@eno1.202 -i 3@eno1.203 -i 4@eno1.204")
    tqdm.write("Switch {} restarted.".format(switch.host))

100% 2/2 [00:05<00:00, 2.70s/it]
Switch 129.114.108.173 restarted.
Switch 192.5.87.102 restarted.

3. Start cross-traffic
[19]: from chi.ssh import Remote
import time

cross_tacc = Remote(ip="129.114.108.104")
cross_tacc.run("sudo pkill -f iperf3")
time.sleep(2)
```

Screencast of a complex experiment: <https://vimeo.com/297210055>

SHARING, PUBLISHING, LEVERAGING

- ▶ We now have everything we need to share experiments
 - ▶ Ways to establish an experimental environment + player
 - ▶ Ways to document an experimental process
- ▶ But wait... how do I actually share them?
 - ▶ Send mail, Chameleon object store, github...
 - ▶ Publishing via Zenodo: store your experiments and make them citable!
- ▶ Creating bridges, integration
 - ▶ Import/Export from/to Zenodo
- ▶ Making research findable: the sharing platform



SC19 Poster: Sharing and Replicability of Notebook-Based Research on Open Testbeds

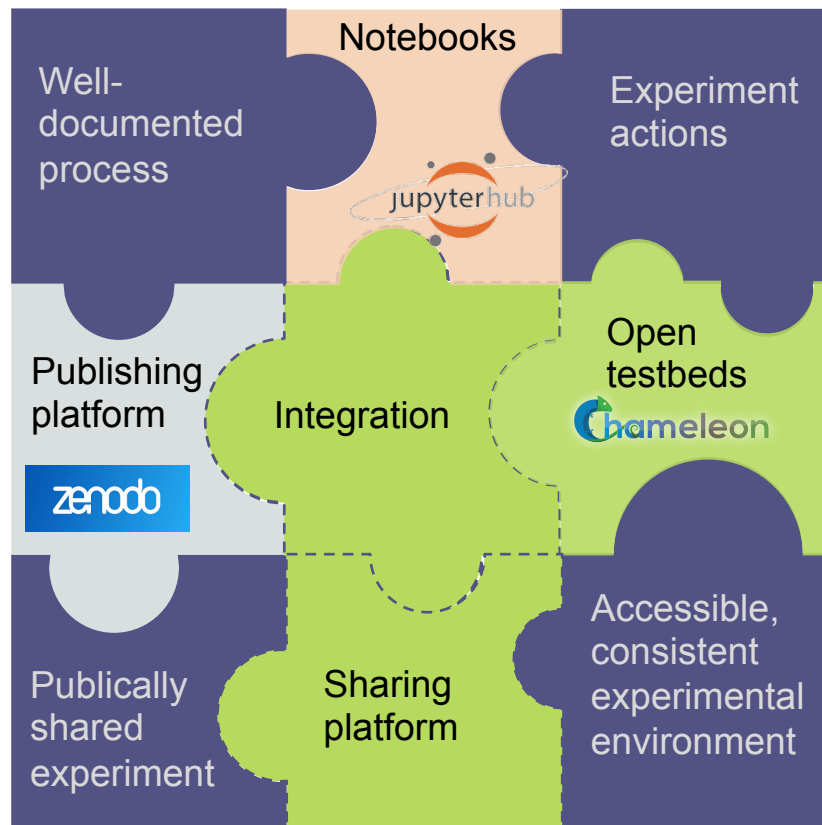

PARTING THOUGHTS

- ▶ Physical environment: a rapidly evolving platform implemented as cloud++
 - ▶ Specially adapted cloud with support for advanced cloud computing research
 - ▶ Originally: “Adapts to the needs of your experiment”
 - ▶ Now also: “Adapts to the needs of its community and the changing research frontier”
- ▶ Towards an Ecosystem: a meeting place of users and providers sharing resources and research
 - ▶ Testbeds are more than just experimental platforms
 - ▶ Common/shared platform is a “common denominator” that can eliminate much complexity that goes into systematic experimentation, sharing, and reproducibility...
 - ▶ ... as well as education!
- ▶ Be part of the change: tell us what capabilities we should provide to help you share and leverage the contributions of others!