



www.chameleoncloud.org

EXPERIMENTING IN THE EDGE TO CLOUD CONTINUUM

Kate Keahey

Mathematics and CS Division, Argonne National Laboratory

CASE, University of Chicago

keahey@anl.gov

July 30, 2021

ApPLIED Workshop 2021



CHAMELEON IN A NUTSHELL

- ▶ We like to change: a testbed that adapts itself to your experimental needs
 - ▶ Deep reconfigurability (bare metal) and isolation – but also a small KVM cloud
 - ▶ power on/off, reboot, custom kernel, serial console access, etc.
- ▶ Balance: large-scale versus diverse hardware
 - ▶ Large-scale: ~large homogenous partition (~15,000 cores), ~6 PB of storage distributed over 2 sites (UC, TACC) connected with 100G network
 - ▶ Diverse: ARMs, Atoms, FPGAs, GPUs, Corsix switches, etc.
- ▶ Cloud++: CHameleon Infrastructure (CHI) via mainstream cloud tech
 - ▶ Powered by OpenStack with bare metal reconfiguration (Ironic) + “special sauce”
 - ▶ Blazar contribution recognized as official OpenStack component
- ▶ We live to serve: open, production testbed for Computer Science Research
 - ▶ Started in 10/2014, available since 07/2015, renewed in 10/2017, and recently till end of 2024
 - ▶ Currently 5,500+ users, 700+ projects, 100+ institutions, 300+ publications



BY THE NUMBERS

300+
Papers
published

45
Countries

160+
Institutions

Over
5,500
Users

700+
Projects

5+
Years Old

and 3+ more
years to grow!

CHAMELEON HARDWARE

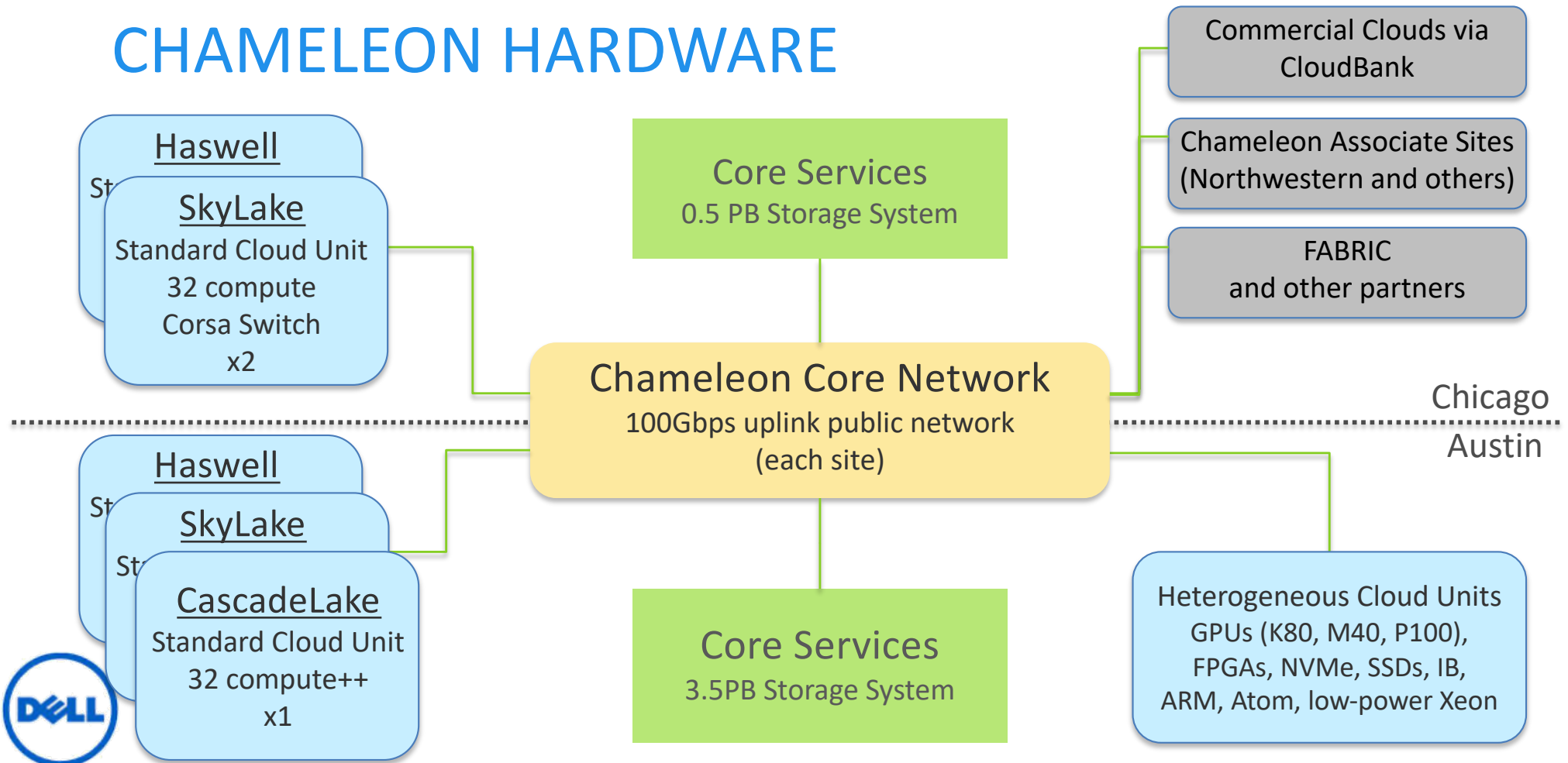

CHAMELEON HARDWARE (DETAILS)

- ▶ “Start with large-scale homogenous partition”
 - ▶ 12 Haswell racks, each with 42 Dell R630 compute servers with dual-socket Intel Haswell processors (24 cores) & 128GB RAM and 4 Dell FX2 storage servers with 16 2TB drives each; Force10 s6000 OpenFlow-enabled switches 10Gb to hosts, 40Gb uplinks to Chameleon core network
 - ▶ 3 SkyLake racks (32 nodes each); Corsa (DP2400 & DP2200), 100Gb uplinks to core network
 - ▶ CascadeLake rack (32 nodes), 100Gb uplinks to Chameleon core network
 - ▶ Allocations can be an entire rack, multiple racks, nodes within a single rack or across racks (e.g., storage servers across racks forming a Hadoop cluster)
- ▶ Shared infrastructure
 - ▶ 3.6 (TACC) + 0.5 (UC) PB global storage, 100Gb Internet connection between sites
- ▶ “Graft on heterogeneous features”
 - ▶ Infiniband with SR-IOV support, High-mem, NVMe, SSDs, P100 GPUs (total of 22 nodes), RTX GPUs (40 nodes), FPGAs (4 nodes)
 - ▶ ARM microservers (24) and Atom microservers (8), low-power Xeons (8)
- ▶ Coming in Phase 3: upgrading Haswells to CascadeLake and IceLake + AMD, new GPUs and FPGAs, more and newer IB fabric, variety of storage options for disaggregated hardware experiments, composable hardware (LiQid), networking (P4, integration with FABRIC), IoT devices -- and strategic reserve

CHI EXPERIMENTAL WORKFLOW

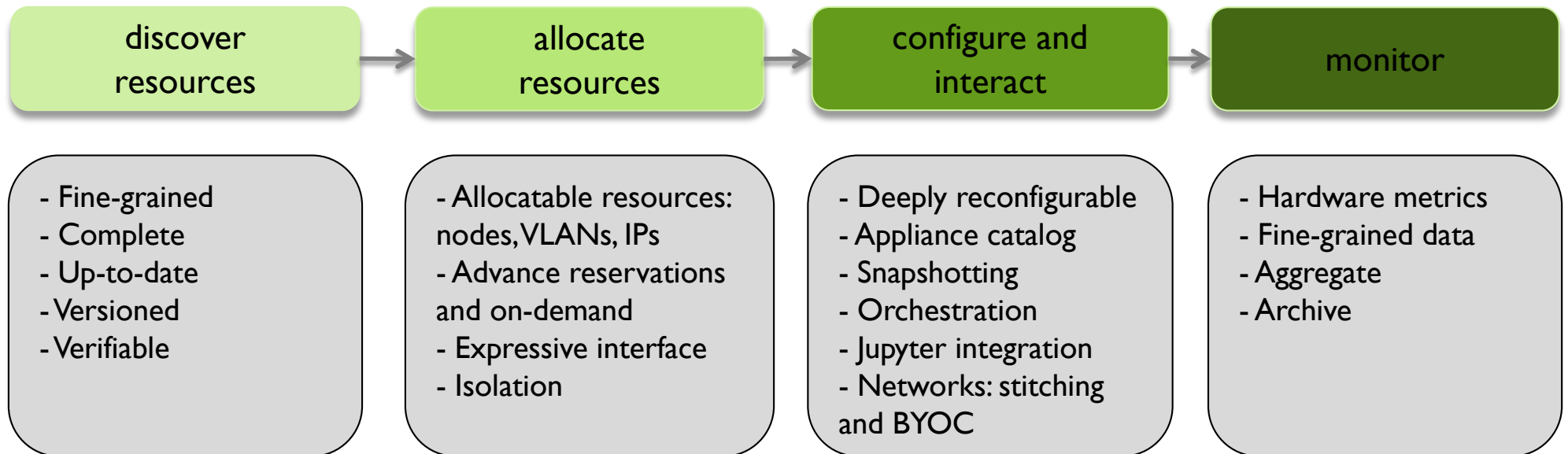

*Authentication via federated identity,
Interfaces via GUI, CLI and python/Jupyter*

VIRTUALIZATION OR CONTAINERIZATION?

- ▶ Yuyu Zhou, University of Pittsburgh
- ▶ Research: lightweight virtualization
- ▶ Testbed requirements:
 - ▶ Bare metal reconfiguration, isolation, and serial console access
 - ▶ The ability to “save your work”
 - ▶ Support for large scale experiments
 - ▶ Up-to-date hardware

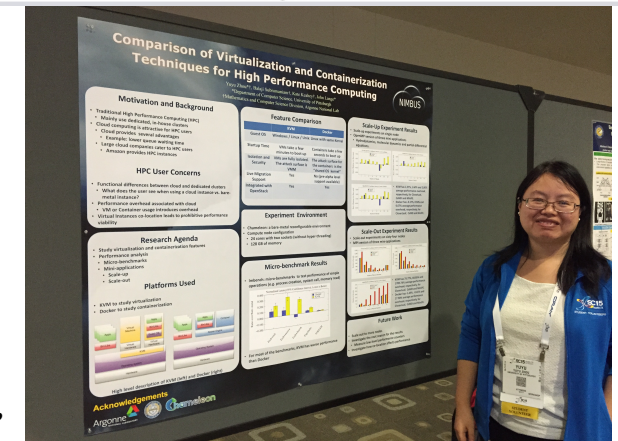
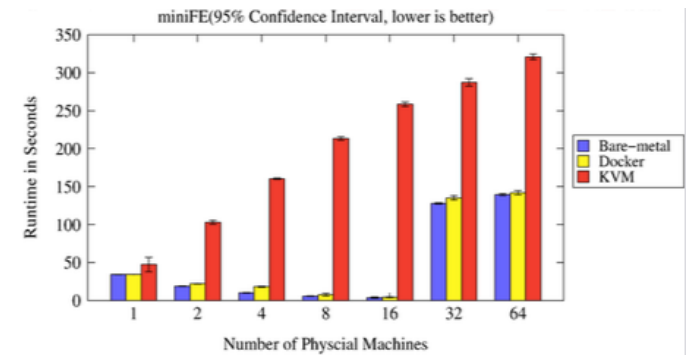

SC15 Poster: “Comparison of Virtualization and Containerization Techniques for HPC”

EXASCALE OPERATING SYSTEMS

- ▶ Swann Perarnau, ANL
- ▶ Research: exascale operating systems
- ▶ Testbed requirements:
 - ▶ Bare metal reconfiguration
 - ▶ Boot from custom kernel with different kernel parameters
 - ▶ Fast reconfiguration, many different images, kernels, parameters
 - ▶ Hardware: accurate information and control over changes, performance counters, many cores
 - ▶ Access to same infrastructure for multiple collaborators

HPPAC'16 paper: “Systemwide Power Management with Argo”

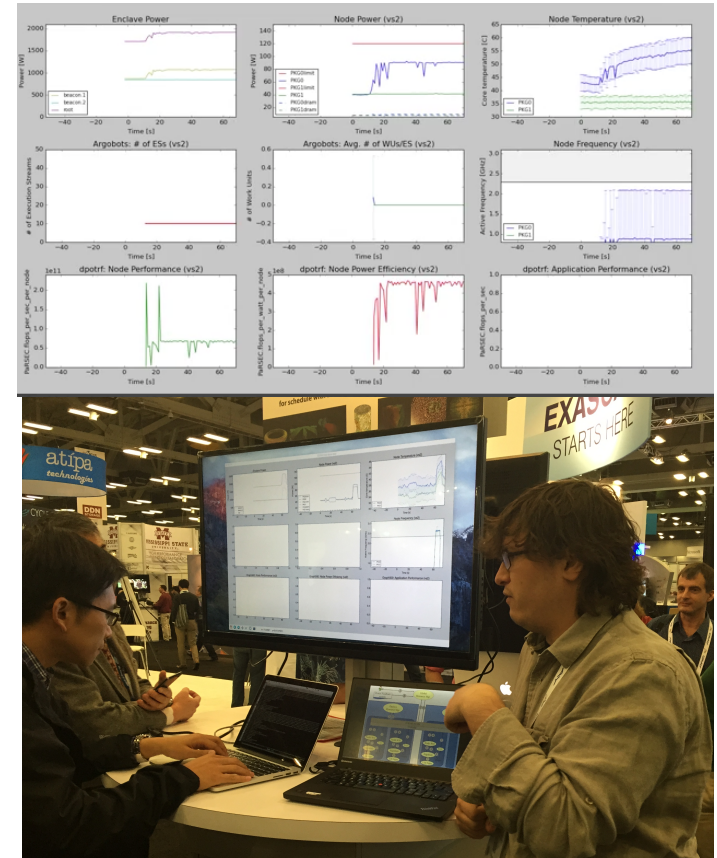

CLASSIFYING CYBERSECURITY ATTACKS

- ▶ Jessie Walker & team, University of Arkansas at Pine Bluff (UAPB)
- ▶ Research: modeling and visualizing multi-stage intrusion attacks (MAS)
- ▶ Testbed requirements:
 - ▶ Easy to use OpenStack installation
 - ▶ A selection of pre-configured images
 - ▶ Access to the same infrastructure for multiple collaborators



CREATING DYNAMIC SUPERFACILITIES

- ▶ NSF CICI SAFE, Paul Ruth, RENCI-UNC Chapel Hill
- ▶ Creating trusted facilities
 - ▶ Automating trusted facility creation
 - ▶ Virtual Software Defined Exchange (SDX)
 - ▶ Secure Authorization for Federated Environments (SAFE)
- ▶ Testbed requirements
 - ▶ Creation of dynamic VLANs and wide-area circuits
 - ▶ Support for network stitching
 - ▶ Managing complex deployments

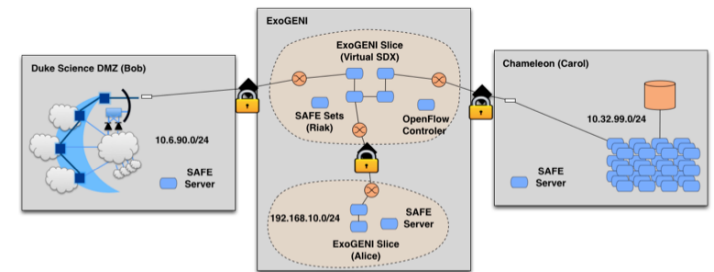

DATA SCIENCE RESEARCH

- ▶ ACM Student Research Competition semi-finalists:
 - ▶ Blue Keleher, University of Maryland
 - ▶ Emily Herron, Mercer University
- ▶ Searching and image extraction in research repositories
- ▶ Testbed requirements:
 - ▶ Access to distributed storage in various configurations
 - ▶ State of the art GPUs
 - ▶ Easy to use appliances and orchestration

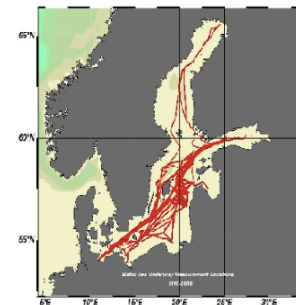

```
{
  "header": {
    "header_info": {
      "jfile": 257,
      "jfile_unit": 1,
      "exit": "exit/v",
      "jfile_version": 1,
      "jfile_density": 1,
      "dpi": [96, 96],
      "image_mode": "RGB",
      "dimensions": "930x",
      "color": {
        "mean_pixel_val": {
          "extrema": [10, 255],
          "mode_pixel_val": {
            "median_pixel_val": {
              "std_dev_pixel_val": {
                "system": {
                  "path": "/media",
                  "extension": ".j",
                  "file": "RGB_end",
                  "size": 1158111,
                  "image_size": [1024, 1024],
                  "name": "hpc",
                  "DOW_class_tag": "1",
                  "mean_color_cluster": {

```

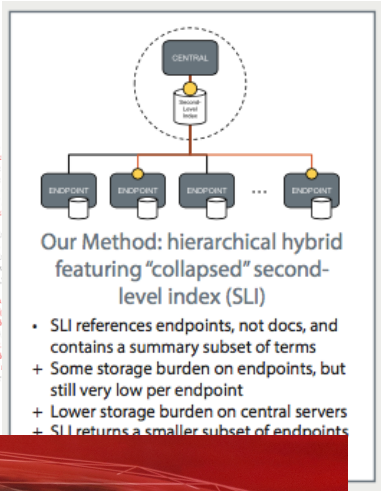

ADAPTIVE BITRATE VIDEO STREAMING

- ▶ Divyashri Bhat, UMass Amherst
- ▶ Research: application header based traffic engineering using P4
- ▶ Testbed requirements:
 - ▶ Distributed testbed facility
 - ▶ BYOC – the ability to write an SDN controller specific to the experiment
 - ▶ Multiple connections between distributed sites
- ▶ <https://vimeo.com/297210055>

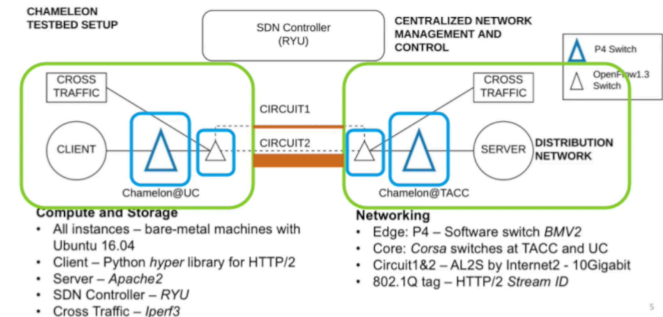

LCN'18: “Application-based QoS support with P4 and OpenFlow”

POWER CAPPING

- ▶ Harper Zhang, University of Chicago
- ▶ Research: hierarchical, distributed, dynamic power management system for dependent applications
- ▶ Testbed requirements:
 - ▶ Support for large-scale experiments
 - ▶ Complex appliances and orchestration (NFS appliance)
 - ▶ RAPL/power management interface
- ▶ Finalist for SC19 Best Paper and Best Student Paper
- ▶ Talk information at bit.ly/SC19PoDD

SC'19: "PoDD: Power-Capping Dependent Distributed Applications"



FEDERATED LEARNING

- ▶ Zheng Chai and Yue Cheng, George Mason University
- ▶ Research: federated learning
- ▶ Testbed requirements:
 - ▶ Bare metal, ability to record network traffic precisely
 - ▶ Support for large-scale and diverse hardware
 - ▶ Powerful nodes with large memory

Paper: “FedAT: A Communication-Efficient Federated Learning Method with Asynchronous Tiers under Non-IID Data”, October 2020

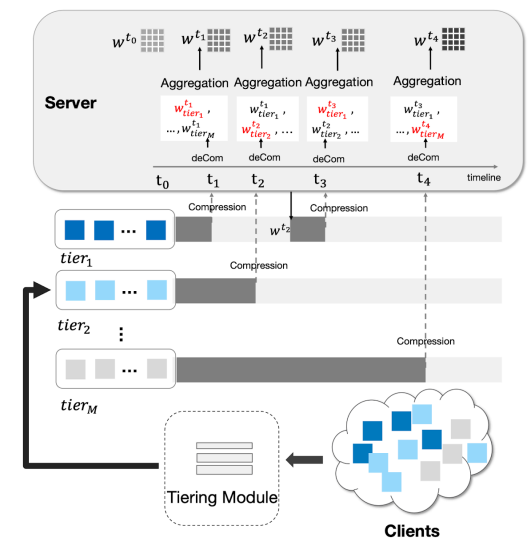
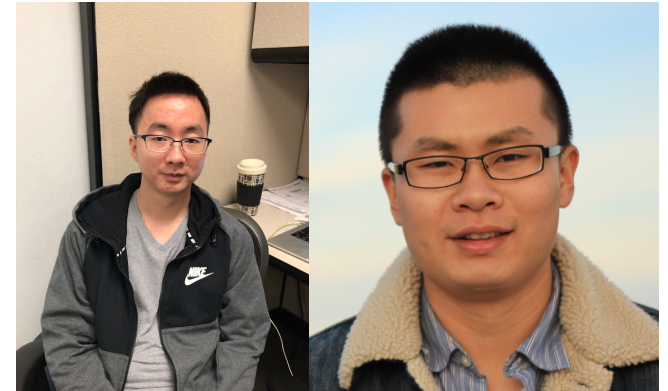

GIVING CHAMELEON AN EDGE

- ▶ What does an edge testbed look like?
 - ▶ A lot like a cloud: all the features you know and love – but via **containers**
 - ▶ Not like a cloud at all: location, location, location -- cameras, actuators, software defined radios (SDRs) – network, hardware, privacy limitations
 - ▶ **CHI@Edge**: mixed-ownership devices managed via an **SDK** via a **virtual site** – but otherwise very similar tried and true interface
 - ▶ Practice makes perfect: **listen to users and adjust**
- ▶ How to build an edge testbed
 - ▶ Familiar challenges: access management, secure network connections, resource management, and other sharing considerations
 - ▶ New challenges: remote locations, power/networking constraints, peripheral devices
 - ▶ Leverage existing investment in (1) open source (OpenStack), and (2) Chameleon

BUILDING CHI@EDGE



CHI@EDGE EXPERIMENTAL WORKFLOW (PREVIEW)

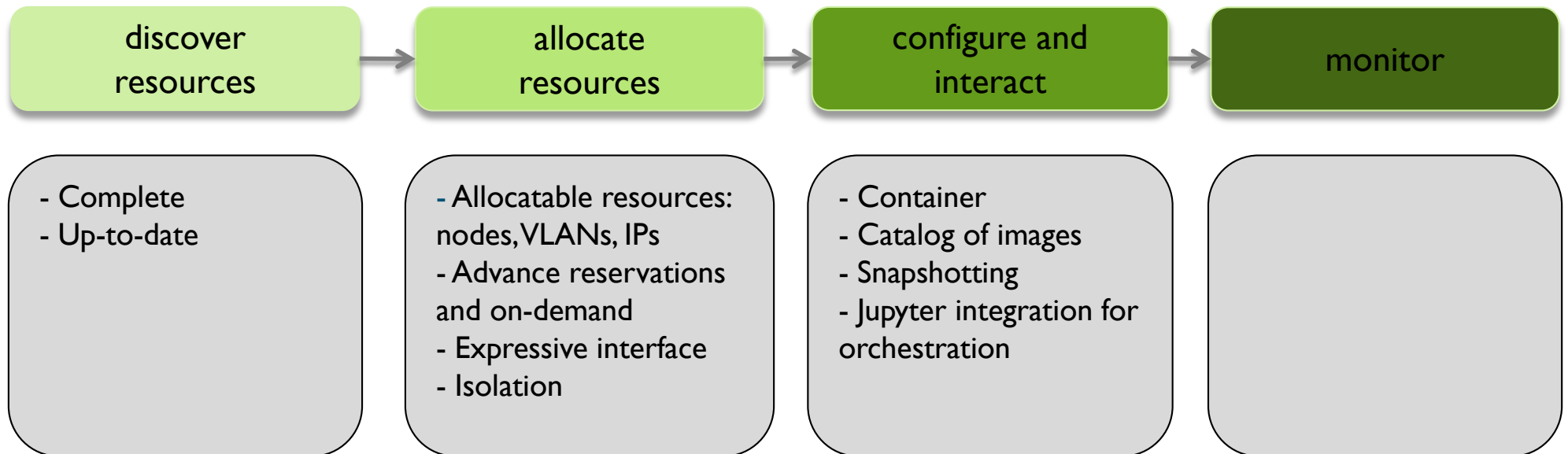

*Authentication via federated identity,
Interfaces via GUI, CLI and python/Jupyter*

CHI AND CHI@EDGE SIDE BY SIDE

Chameleon for bare metal

Advanced reservations for **bare metal machines**

Bare metal reconfigurability

Single-tenant isolation

Heterogeneous collection of interesting hardware

Isolated networking, public IP capability, **OpenFlow SDN**

Composable cloud APIs (GUI, CLI, Python+Jupyter)

Owned and operated by Chameleon

Chameleon for edge

Advanced reservations for **IoT/edge devices**

Container deployment

Single-tenant isolation

Heterogeneous collection of interesting hardware **and peripherals/locations!**

Isolated networking, public IP capability

Composable cloud APIs (GUI, CLI, Python+Jupyter)

Mixed ownership model: bring your own device(s)!

JOIN US FOR THE SUMMER OF CHAMELEON!

- ▶ June 2021: CHI@Edge releases, shared hardware (nvidia nanos and raspberry pis), community webinars
- ▶ July 2021: “bring your own device” with attestations/SLAs, peripherals, support for limited sharing
- ▶ To use: <https://www.chameleoncloud.org/experiment/chiedge/>
- ▶ To learn: <https://www.youtube.com/user/ChameleonCloud/videos>
- ▶ To interact: <https://groups.google.com/g/chameleon-edge-users?pli=1>
- ▶ Help us build a better testbed!

PRACTICAL REPRODUCIBILITY

- ▶ **Can experiments be as sharable as papers are today?**
- ▶ Reproducibility baseline: sharing hardware via instruments held in common
- ▶ Clouds: sharing experimental environments
 - ▶ Disk images, orchestration templates, and other artifacts
- ▶ What is missing?
 - ▶ Telling the whole story: hardware + experimental container + experiment workflow + data analysis + story – literate programming
 - ▶ The easy button: it has to be easy to package, easy to repeat, easy to find, easy to get credit for, easy to reference, etc.
 - ▶ Nits and optimizations: declarative versus imperative, transactional versus transparent

Paper: “The Silver Lining”, IEEE Internet Computing 2020

EXPERIMENT SHARING IN CHAMELEON

- ▶ Hardware and hardware versions
 - ▶ >105 versions over 5 years
 - ▶ Expressive allocation
- ▶ Images and orchestration
 - ▶ >130,000 images, >35,000 orchestration templates and counting
- ▶ Packaging and repeating: integration with JupyterLab
- ▶ Share, find, publish and cite: Trovi and Zenodo



TROVI: CHAMELEON'S EXPERIMENT PORTAL

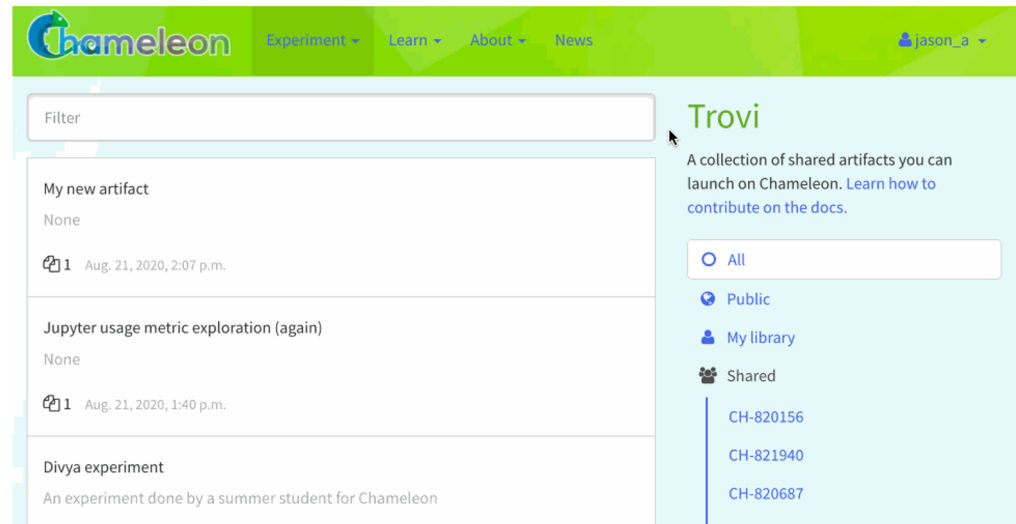
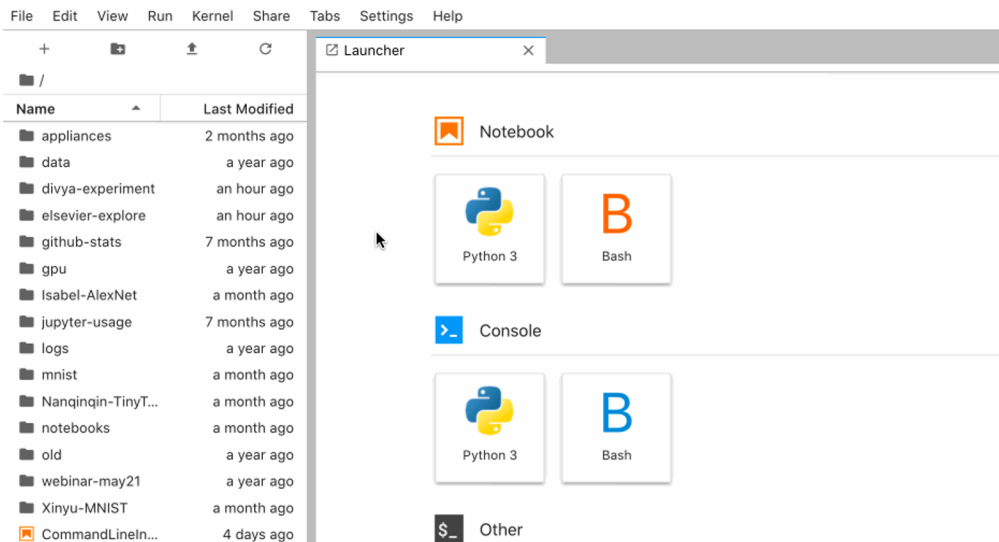

Create a new packaged experiment out of any directory of files in your Jupyter server. It is private to you unless shared. Supports sharing similar to Google Drive.

Any user with a Chameleon allocation can find and "replay" the packaged experiment.

PUBLISHING EXPERIMENTS

Familiar research sharing ecosystem

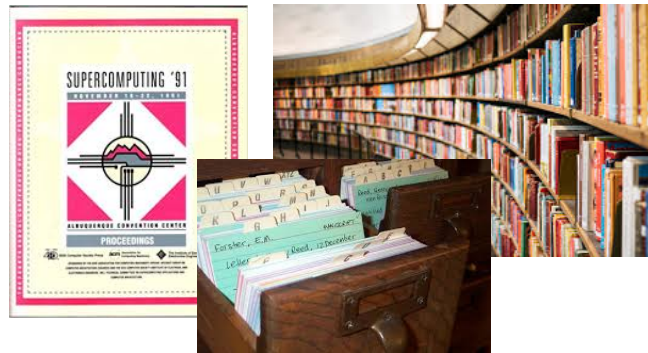

Digital research sharing ecosystem



- ▶ Digital publishing with Zenodo: make your experimental artifacts citable via Digital Object Identifiers (DOIs)
- ▶ Integration with Zenodo
 - ▶ Export: make your research citable and discoverable
 - ▶ Import: access a wealth of digital research artifacts already published



PARTING THOUGHTS

- ▶ Scientific instruments: laying down the pavement as science walks on it
- ▶ Chameleons like to change:
 - ▶ Experimental environments that can adapt to your experiment
 - ▶ CHI@Edge – from cloud to edge – testbed that adapts itself to your scientific needs
 - ▶ Still in preview but supporting exciting applications in self-driving cars, marine biology, and
- ▶ From shareable research instrument to a sharing platform
 - ▶ Clouds help us package experimental environments almost as a side-effect
 - ▶ Literate programming is a convenient vehicle for “closing the gap”: packaging the whole experiment so that it can be reproduced easily
 - ▶ The easy button: making reproducibility sustainable will rely on creating “research marketplace”: sharing experiments as naturally as we share papers now



We're here to change – come and change with us!

www.chameleoncloud.org